

Northern

Price list

2023 - 2024

Valid 01.09.2023 — 31.08.2024
NOK, SEK, DKK, EUR

Northern

We combine beauty with functionality and prefer natural materials and genuine craftsmanship. Furniture, lighting and interior accessories are a natural fit for what we do, enabling us to express our characteristic style.

Inspired by the pale beauty and rough-cut contrasts of the North, the Oslo-based brand is Nordic in spirit, yet global in style.

northern.no





News AW23



Gem lounge chair with armrest
P. 21



Ton side table
P. 53

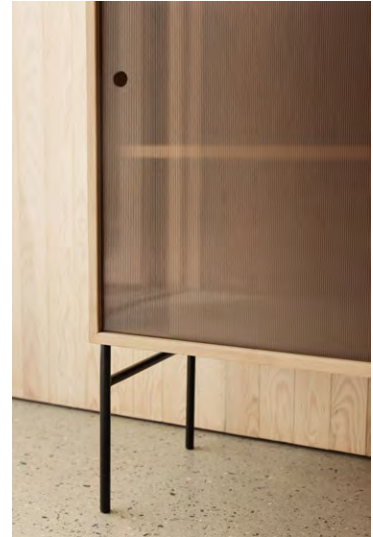

Hifive glass storage
P. 24



Archive table lamp
P. 90



Kin table lamp
P. 118

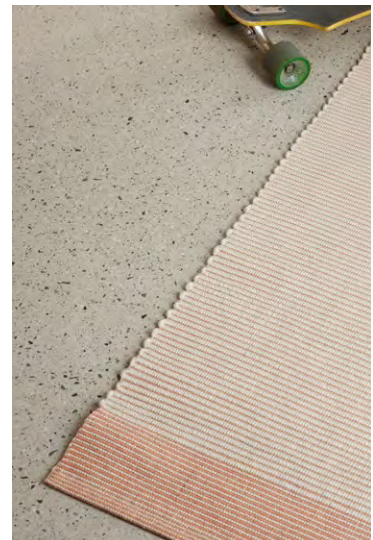

Spool rug
P. 83



Echo throw blanket
P. 67



Gem pouf
P. 22



Echo cushion cover
P. 64



Cling coffee table
P. 10



Into vase
P. 73



Gem lounge chair
P. 20

Content

Furniture

Cling coffee table*	P. 10
Daybe sofa	P. 12
Daybe with armrest	P. 13
Daybe dining sofa	P. 14
Daybe daybed	P. 15
Expand table series	P. 17
Gem lounge chair*	P. 20
Gem lounge chair with armrests*	P. 21
Gem pouf*	P. 22
Gem sofa	P. 23
Hifive glass cabinet*	P. 24
Hifive glass storage system*	P. 26
Hifive storage system	P. 30
Hifive slim wall	P. 34
Loud bar cabinet	P. 37
Loud tall cabinet	P. 38
Loud sideboard	P. 39
Mass side table	P. 40
Oak dining chair	P. 41
Oak lounge chair	P. 42
Oblong lounge chair	P. 44
Oblong sofa	P. 45
Pal stool	P. 46
Pal bench	P. 47
Plis 2 seater sofa	P. 48
Plis 3 seater sofa	P. 49
Shelter desk	P. 50
Stilk coffee table	P. 51
Ton side table*	P. 53
Treble bar stool	P. 54
Valet wall console	P. 55
Valet wall drawer	P. 56
Yam lounge chair	P. 57
Yam pouf medium	P. 58
Yam pouf small	P. 59

Accessories

Brim vase	P. 61
Cane broom set	P. 62
Dais stepstool	P. 63
Echo cushion*	P. 64
Echo throw blanket*	P. 67
Frame wall rack	P. 68
Grab watering can	P. 69
Granny candle holder	P. 70
Into vase*	P. 73
Mim outdoor broom	P. 74
Monolith candle holder	P. 75
Nest wall hook	P. 76
Nook rack	P. 77
Oasis planter	P. 78
Observe tray	P. 79
Peek mirror	P. 80
Podium board	P. 81
Row rug	P. 82
Spool rug*	P. 83
Trace flashlight	P. 85
Lighting	
Acorn floor	P. 88
Acorn pendant	P. 89
Archive table*	P. 90
Balancer floor	P. 92
Balancer wall	P. 93
Balancer mini wall/table	P. 94
Birdy floor	P. 95
Birdy floor swing	P. 96
Birdy table	P. 97
Birdy table swing	P. 98
Birdy wall	P. 99
Blush pendant	P. 100
Blush rail 3 pendant	P. 101
Blush rail 5 pendant	P. 102
Blush wall	P. 103

Buddy floor	P. 104
Buddy table	P. 105
Buddy wall	P. 106
Butterfly wall	P. 107
Butterfly perforated	P. 108
Circle pendant	P. 109
Dahl pendant	P. 110
Diva series	P. 111
Dokka pendant	P. 112
Gear floor	P. 113
Gear table	P. 114
Glint wall	P. 115
Heat pendant	P. 116
Ink wall	P. 117
Kin table*	P. 118
Me dim floor	P. 120
Moo wall	P. 121
Ombre table	P. 122
Oslo Wood floor	P. 123
Over Me series	P. 124
Reveal pendant	P. 125
Salto floor	P. 126
Salto table	P. 127
Say My Name series	P. 129
Snowball floor	P. 130
Snowball table	P. 131
Tradition pendant	P. 132
Unika pendant	P. 133
Spare parts	P. 134
Terms & Conditions	P. 138

New products *



Furniture

Cling coffee table

P. 10



Cling coffee table D70H43 light oiled oak
– Item no. 2651



Cling coffee table D70H43 smoked oak
– Item no. 2650



Cling coffee table D90H38 light oiled oak
– Item no. 2641



Cling coffee table D90H38 smoked oak
– Item no. 2640

Product type: Coffee table series
Design: Anton Björnsing, 2023
Material legs and top: Solid oak
Material base: Chipboard, oak veneer
Colours: Light oiled oak or smoked oak finish
Net weight: 11.5 kg (D70), 16.0 kg (D90)
Minimum order size: 1

Dimensions (cm):

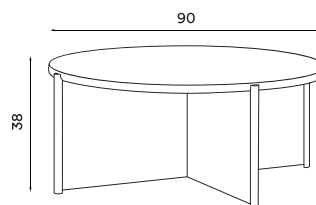
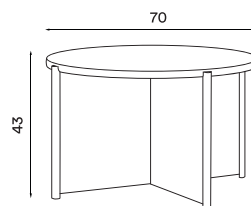

Prices NOK	(RRP ex. VAT)	(RRP incl. VAT)	Prices SEK	(RRP ex. VAT)	(RRP incl. VAT)
Cling D70H43	7 992,-	9 990,-	Cling D70H43	8 792,-	10 990,-
Cling D90H38	10 392,-	12 990,-	Cling D90H38	11 592,-	14 490,-

Prices DKK	(RRP ex. VAT)	(RRP incl. VAT)	Prices Euro	(RRP ex. VAT)	(RRP incl. VAT)
Cling D70H43	6 152,-	7 690,-	Cling D70H43	833,-	999,-
Cling D90H38	7 992,-	9 990,-	Cling D90H38	1 083,-	1 299,-







Daybe price group 0 – *Item no. 2269*
 Daybe price group 1 – *Item no. 2001*
 Daybe price group 2 – *Item no. 2002*

Daybe price group 3 – *Item no. 2003*
 Daybe price group 4 – *Item no. 2270*

Product type: Sofa (bed)

Design: Morten & Jonas, 2018

Material legs: Steel

Colour legs: Black (Ral 9005)

Material body: Plywood base, cold foam filling, textile cover

Price group 0: Cura (Gabriel)

Price group 1: Brusvik, Reflect (Kvadrat)

Price group 2: Remix 3, Atlas (Kvadrat)

Price group 3: Steelcut Trio 3, Fiord 2, Canvas 2 (Kvadrat)

Price group 4: Vidar, Moss (Kvadrat)

Net weight: 48.0 kg

Minimum order size: 1

Made to order

Dimensions (cm):

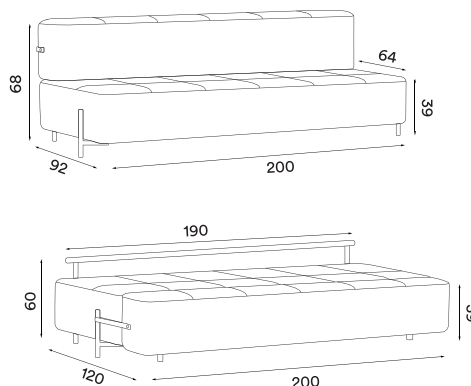

Prices NOK	(RRP ex. VAT)	(RRP incl. VAT)
Price group 0	19 992,-	24 990,-
Price group 1	25 592,-	31 990,-
Price group 2	33 592,-	41 990,-
Price group 3	35 192,-	43 990,-
Price group 4	35 992,-	44 990,-

Prices SEK	(RRP ex. VAT)	(RRP incl. VAT)
Price group 0	21 592,-	26 990,-
Price group 1	27 992,-	34 990,-
Price group 2	37 592,-	46 990,-
Price group 3	39 192,-	48 990,-
Price group 4	39 992,-	49 990,-

Prices DKK	(RRP ex. VAT)	(RRP incl. VAT)
Price group 0	15 992,-	19 990,-
Price group 1	19 192,-	23 990,-
Price group 2	25 592,-	31 990,-
Price group 3	27 192,-	33 990,-
Price group 4	28 792,-	35 990,-

Prices Euro	(RRP ex. VAT)	(RRP incl. VAT)
Price group 0	2 249,-	2 699,-
Price group 1	2 749,-	3 299,-
Price group 2	3 583,-	4 299,-
Price group 3	3 916,-	4 699,-
Price group 4	3 999,-	4 799,-



Daybe armrest price group 0 – *Item no. 2267*

Daybe armrest price group 1 – *Item no. 2261*

Daybe armrest price group 2 – *Item no. 2262*

Daybe armrest price group 3 – *Item no. 2263*

Daybe armrest price group 4 – *Item no. 2268*

Product type: Sofa (bed)

Design: Morten & Jonas, 2018

Material legs and armrests: Steel

Colour legs and armrests: Black (Ral 9005)

Material body: Plywood base, cold foam filling, textile cover

Price group 0: Cura (Gabriel)

Price group 1: Brusvik, Reflect (Kvadrat)

Price group 2: Remix 3, Atlas (Kvadrat)

Price group 3: Steelcut Trio 3, Fiord 2, Canvas 2 (Kvadrat)

Price group 4: Vidar, Moss (Kvadrat)

Net weight: 52.5 kg

Minimum order size: 1

Made to order

Dimensions (cm):

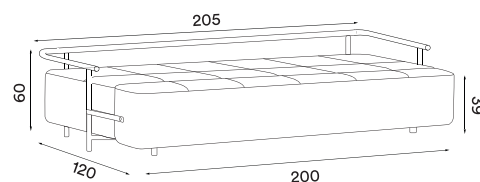
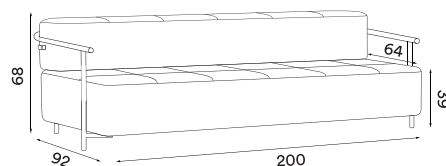

Prices NOK	(RRP ex. VAT)	(RRP incl. VAT)
Price group 0	22 392,-	27 990,-
Price group 1	27 792,-	34 990,-
Price group 2	35 992,-	44 990,-
Price group 3	37 592,-	46 990,-
Price group 4	38 392,-	47 990,-

Prices DKK	(RRP ex. VAT)	(RRP incl. VAT)
Price group 0	18 392,-	22 990,-
Price group 1	21 592,-	26 990,-
Price group 2	27 992,-	34 990,-
Price group 3	29 592,-	36 990,-
Price group 4	31 192,-	38 990,-

Prices SEK	(RRP ex. VAT)	(RRP incl. VAT)
Price group 0	24 792,-	30 990,-
Price group 1	31 192,-	38 990,-
Price group 2	40 792,-	50 990,-
Price group 3	41 592,-	51 990,-
Price group 4	43 192,-	53 990,-

Prices Euro	(RRP ex. VAT)	(RRP incl. VAT)
Price group 0	2 499,-	2 999,-
Price group 1	2 999,-	3 599,-
Price group 2	3 833,-	4 599,-
Price group 3	4 166,-	4 999,-
Price group 4	4 249,-	5 099,-

Daybe dining sofa

P. 14



Daybe dining sofa (black legs)
 Price group 0 – Item no. 2510
 Price group 1 – Item no. 2511
 Price group 2 – Item no. 2512
 Price group 3 – Item no. 2513
 Price group 4 – Item no. 2514

Daybe dining sofa (white legs)
 Price group 0 – Item no. 2520
 Price group 1 – Item no. 2521
 Price group 2 – Item no. 2522
 Price group 3 – Item no. 2523
 Price group 4 – Item no. 2524

Product type: Dining sofa

Design: Morten & Jonas, 2022

Material legs: Steel

Colour legs: Black (Ral 9005) or white (Ral 9002)

Material body: Plywood base, cold foam filling, textile cover

Price group 0: Cura (Gabriel)

Price group 1: Brusvik, Reflect (Kvadrat)

Price group 2: Remix 3, Atlas (Kvadrat)

Price group 3: Steelcut Trio 3, Fiord 2, Canvas 2 (Kvadrat)

Price group 4: Vidar, Moss (Kvadrat), Ultra leather (Sørensen Leather)

Net weight: 45 kg

Minimum order size: 1

Made to order

Dimensions (cm):

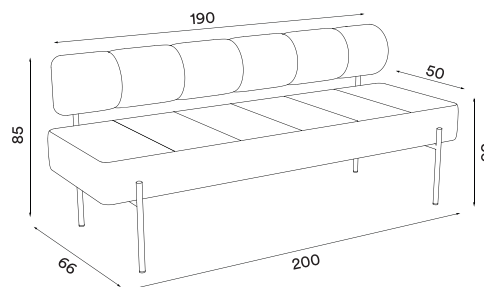

Prices NOK	(RRP ex. VAT)	(RRP incl. VAT)
Price group 0	15 992,-	19 990,-
Price group 1	19 992,-	24 990,-
Price group 2	21 592,-	26 990,-
Price group 3	26 392,-	32 990,-
Price group 4	27 992,-	34 990,-

Prices DKK	(RRP ex. VAT)	(RRP incl. VAT)
Price group 0	12 792,-	15 990,-
Price group 1	15 592,-	19 490,-
Price group 2	16 792,-	20 990,-
Price group 3	19 992,-	24 990,-
Price group 4	21 592,-	26 990,-

Prices SEK	(RRP ex. VAT)	(RRP incl. VAT)
Price group 0	17 592,-	21 990,-
Price group 1	21 592,-	26 990,-
Price group 2	23 992,-	29 990,-
Price group 3	28 792,-	35 990,-
Price group 4	30 392,-	37 990,-

Prices Euro	(RRP ex. VAT)	(RRP incl. VAT)
Price group 0	1 833,-	2 199,-
Price group 1	2 083,-	2 499,-
Price group 2	2 249,-	2 699,-
Price group 3	2 749,-	3 299,-
Price group 4	2 916,-	3 499,-





Daybe daybed w/pillow (black legs)

Price group 0 – *Item no. 2530*

Price group 1 – *Item no. 2531*

Price group 2 – *Item no. 2532*

Price group 3 – *Item no. 2533*

Price group 4 – *Item no. 2534*

Daybe daybed w/pillow (white legs)

Price group 0 – *Item no. 2540*

Price group 1 – *Item no. 2541*

Price group 2 – *Item no. 2542*

Price group 3 – *Item no. 2543*

Price group 4 – *Item no. 2544*

Product type: Daybed

Design: Morten & Jonas, 2022

Material legs: Steel

Colour legs: Black (Ral 9005) or white (Ral 9002)

Material body: Plywood base, cold foam filling, textile cover

Material pillow: Cold foam and feather filling, leather straps, textile cover

Price group 0: Cura (Gabriel)

Price group 1: Brusvik, Reflect (Kvadrat)

Price group 2: Remix 3, Atlas (Kvadrat)

Price group 3: Steelcut Trio 3, Fiord 2, Canvas 2 (Kvadrat)

Price group 4: Vidar, Moss (Kvadrat), Ultra leather (Sørensen Leather)

Net weight: 27 kg

Minimum order size: 1

Made to order

Dimensions (cm):

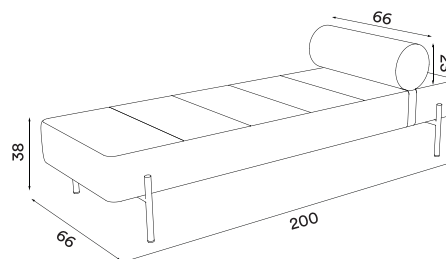

Prices NOK	(RRP ex. VAT)	(RRP incl. VAT)
Price group 0	12 792,-	15 990,-
Price group 1	15 992,-	19 990,-
Price group 2	17 592,-	21 990,-
Price group 3	19 992,-	24 990,-
Price group 4	21 592,-	26 990,-

Prices SEK	(RRP ex. VAT)	(RRP incl. VAT)
Price group 0	14 392,-	17 990,-
Price group 1	17 592,-	21 990,-
Price group 2	19 192,-	23 990,-
Price group 3	21 592,-	26 990,-
Price group 4	23 992,-	29 990,-

Prices DKK	(RRP ex. VAT)	(RRP incl. VAT)
Price group 0	10 392,-	12 990,-
Price group 1	12 792,-	15 990,-
Price group 2	13 592,-	16 990,-
Price group 3	15 592,-	19 490,-
Price group 4	16 792,-	20 990,-

Prices Euro	(RRP ex. VAT)	(RRP incl. VAT)
Price group 0	1 499,-	1 799,-
Price group 1	1 666,-	1 999,-
Price group 2	1 916,-	2 299,-
Price group 3	2 166,-	2 599,-
Price group 4	2 333,-	2 799,-

Daybe daybed pillow

P. 16



Daybe daybed extra pillow
 Price group 0 – *Item no. 2500*
 Price group 1 – *Item no. 2501*

Price group 2 – *Item no. 2502*
 Price group 3 – *Item no. 2503*
 Price group 4 – *Item no. 2504*

Product type: Daybed pillow

Design: Morten & Jonas, 2022

Materials: Cold foam and feather filling, leather straps, textile cover

Price group 0: Cura (Gabriel)

Price group 1: Brusvik, Reflect (Kvadrat)

Price group 2: Remix 3, Atlas (Kvadrat)

Price group 3: Steelcut Trio 3, Fiord 2, Canvas 2 (Kvadrat)

Price group 4: Vidar, Moss (Kvadrat), Ultra leather (Sørensen Leather)

Net weight: 2.0 kg

Minimum order size: 1

Made to order

Dimensions (cm):

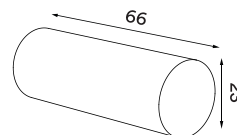

Prices NOK	(RRP ex. VAT)	(RRP incl. VAT)
Price group 0	2 392,-	2 990,-
Price group 1	3 192,-	3 990,-
Price group 2	3 432,-	4 290,-
Price group 3	3 912,-	4 890,-
Price group 4	4 232,-	5 290,-

Prices SEK	(RRP ex. VAT)	(RRP incl. VAT)
Price group 0	2 632,-	3 290,-
Price group 1	3 512,-	4 390,-
Price group 2	3 752,-	4 690,-
Price group 3	4 312,-	5 390,-
Price group 4	4 632,-	5 790,-

Prices DKK	(RRP ex. VAT)	(RRP incl. VAT)
Price group 0	1 992,-	2 490,-
Price group 1	2 472,-	3 090,-
Price group 2	2 632,-	3 290,-
Price group 3	3 032,-	3 790,-
Price group 4	3 272,-	4 090,-

Prices Euro	(RRP ex. VAT)	(RRP incl. VAT)
Price group 0	274,-	329,-
Price group 1	333,-	399,-
Price group 2	374,-	449,-
Price group 3	416,-	499,-
Price group 4	458,-	549,-



Expand table circular 120

P. 17



Expand dining table circular 120
light oiled oak – *Item no. 2620*



Expand dining table circular 120
smoked oak – *Item no. 2621*



Expand dining table circular 120
black painted oak – *Item no. 2622*



Expand table extension 120 x 50
light oiled oak – *Item no. 2623*



Expand table extension 120 x 50
smoked oak – *Item no. 2624*



Expand table extension 120 x 50
black painted oak – *Item no. 2625*

Product type: Dining table
Design: Sami Kallio, 2022
Material: Solid oak
Colours: Light oiled oak, smoked oak finish or black painted oak
Net weight table: 45 kg
Net weight extension: 15 kg
Maximum length: 220 cm
Minimum order size: 1

Dimensions (cm):

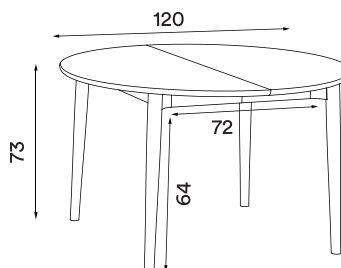

Prices NOK	(RRP ex. VAT)	(RRP incl. VAT)
Table light/smoked	26 392,-	32 990,-
Table black	31 992,-	39 990,-
Extension light/smoked	5 192,-	6 490,-
Extension black	6 392,-	7 990,-

Prices SEK	(RRP ex. VAT)	(RRP incl. VAT)
Table light/smoked	28 792,-	35 990,-
Table black	35 192,-	43 990,-
Extension light/smoked	5 592,-	6 990,-
Extension black	7 192,-	8 990,-

Prices DKK	(RRP ex. VAT)	(RRP incl. VAT)
Table light/smoked	19 992,-	24 990,-
Table black	23 992,-	29 990,-
Extension light/smoked	3 992,-	4 990,-
Extension black	4 792,-	5 990,-

Prices Euro	(RRP ex. VAT)	(RRP incl. VAT)
Table light/smoked	2 833,-	3 399,-
Table black	3 416,-	4 099,-
Extension light/smoked	563,-	675,-
Extension black	688,-	825,-



Expand table 200

P. 18



Expand dining table 200 x 90
light oiled oak – *Item no. 2611*



Expand dining table 200 x 90
smoked oak – *Item no. 2612*



Expand dining table 200 x 90
black painted oak – *Item no. 2613*



Expand table extension 90 x 50
light oiled oak – *Item no. 2617*



Expand table extension 90 x 50
smoked oak – *Item no. 2618*



Expand table extension 90 x 50
black painted oak – *Item no. 2619*

Product type: Dining table
Design: Sami Kallio, 2022
Material: Solid oak
Colours: Light oiled oak, smoked oak finish or black painted oak
Net weight table: 53 kg
Net weight extension: 11 kg
Maximum length: 300 cm
Minimum order size: 1

Dimensions (cm):

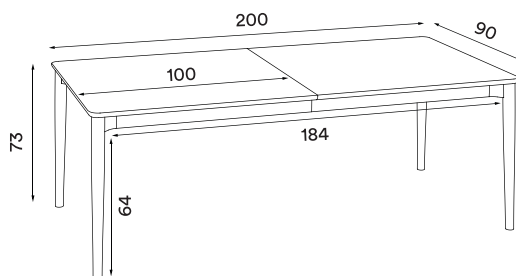

Prices NOK	(RRP ex. VAT)	(RRP incl. VAT)
Table light/smoked	30 392,-	37 990,-
Table black	35 992,-	44 990,-
Extension light/smoked	4 392,-	5 490,-
Extension black	5 592,-	6 990,-

Prices SEK	(RRP ex. VAT)	(RRP incl. VAT)
Table light/smoked	33 592,-	41 990,-
Table black	39 992,-	49 990,-
Extension light/smoked	4 799,-	5 999,-
Extension black	5 992,-	7 490,-

Prices DKK	(RRP ex. VAT)	(RRP incl. VAT)
Table light/smoked	23 992,-	29 990,-
Table black	27 992,-	34 990,-
Extension light/smoked	3 352,-	4 190,-
Extension black	4 392,-	5 490,-

Prices Euro	(RRP ex. VAT)	(RRP incl. VAT)
Table light/smoked	3 333,-	3 999,-
Table black	3 833,-	4 599,-
Extension light/smoked	479,-	575,-
Extension black	604,-	725,-



Expand table 250

P. 19



Expand dining table 250 x 90
light oiled oak – *Item no. 2614*



Expand dining table 250 x 90
smoked oak – *Item no. 2615*



Expand dining table 250 x 90
black painted oak – *Item no. 2616*



Expand table extension 90 x 50
light oiled oak – *Item no. 2617*



Expand table extension 90 x 50
smoked oak – *Item no. 2618*



Expand table extension 90 x 50
black painted oak – *Item no. 2619*

Product type: Dining table
Design: Sami Kallio, 2022
Material: Solid oak
Colours: Light oiled oak, smoked oak finish or black painted oak
Net weight table: 62 kg
Net weight extension: 11 kg
Maximum length: 350 cm
Minimum order size: 1

Dimensions (cm):

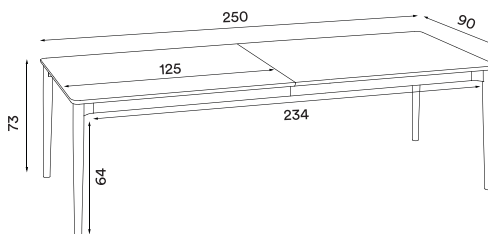

Prices NOK	(RRP ex. VAT)	(RRP incl. VAT)
Table light/smoked	34 392,-	42 990,-
Table black	39 992,-	49 990,-
Extension light/smoked	4 392,-	5 490,-
Extension black	5 592,-	6 990,-

Prices SEK	(RRP ex. VAT)	(RRP incl. VAT)
Table light/smoked	38 392,-	47 990,-
Table black	43 992,-	54 990,-
Extension light/smoked	4 799,-	5 999,-
Extension black	5 992,-	7 490,-

Prices DKK	(RRP ex. VAT)	(RRP incl. VAT)
Table light/smoked	26 392,-	32 990,-
Table black	31 192,-	38 990,-
Extension light/smoked	3 352,-	4 190,-
Extension black	4 392,-	5 490,-

Prices Euro	(RRP ex. VAT)	(RRP incl. VAT)
Table light/smoked	3 749,-	4 499,-
Table black	4 166,-	4 999,-
Extension light/smoked	479,-	575,-
Extension black	604,-	725,-



Gem lounge chair

P. 20



Gem lounge chair price group 0 – *Item no. 2740*

Gem lounge chair price group 1 – *Item no. 2741*

Gem lounge chair price group 2 – *Item no. 2742*

Gem lounge chair price group 3 – *Item no. 2743*

Gem lounge chair price group 4 – *Item no. 2744*

Product type: Lounge chair

Design: Meike Harde, 2023

Material legs: Oak

Colour legs: Light oiled oak, smoked oak finish or black painted oak

Materials seat and backrest: Plywood base, cold foam filling, textile cover

Price group 0: Cura (Gabriel)

Price group 1: Brusvik, Reflect (Kvadrat)

Price group 2: Remix 3, Atlas (Kvadrat)

Price group 3: Steelcut Trio 3, Fiord 2, Canvas 2 (Kvadrat)

Price group 4: Vidar, Moss (Kvadrat)

Net weight: 18.0 kg

Minimum order size: 1

Made to order

Dimensions (cm):

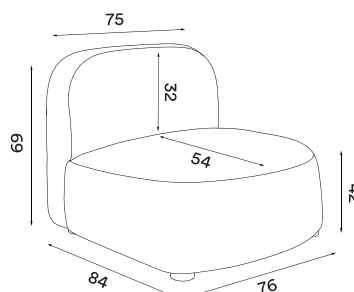

Prices NOK	(RRP ex. VAT)	(RRP incl. VAT)
Price group 0	11 992,-	14 990,-
Price group 1	14 392,-	17 990,-
Price group 2	15 992,-	19 990,-
Price group 3	18 392,-	22 990,-
Price group 4	19 992,-	24 990,-

Prices DKK	(RRP ex. VAT)	(RRP incl. VAT)
Price group 0	10 392,-	12 990,-
Price group 1	11 592,-	14 490,-
Price group 2	12 392,-	15 490,-
Price group 3	14 392,-	17 990,-
Price group 4	15 592,-	19 490,-

Prices SEK	(RRP ex. VAT)	(RRP incl. VAT)
Price group 0	13 192,-	16 490,-
Price group 1	15 992,-	19 990,-
Price group 2	17 592,-	31 990,-
Price group 3	19 992,-	24 990,-
Price group 4	21 592,-	26 990,-

Prices Euro	(RRP ex. VAT)	(RRP incl. VAT)
Price group 0	1 249,-	1 499,-
Price group 1	1 499,-	1 799,-
Price group 2	1 666,-	1 999,-
Price group 3	1 916,-	2 299,-
Price group 4	2 083,-	2 499,-



Gem lounge chair with armrest

P. 21



Gem lounge chair with armrest price group 0 – *Item no. 2730*

Gem lounge chair with armrest price group 1 – *Item no. 2731*

Gem lounge chair with armrest price group 2 – *Item no. 2732*

Gem lounge chair with armrest price group 3 – *Item no. 2733*

Gem lounge chair with armrest price group 4 – *Item no. 2734*

Product type: Lounge chair

Design: Meike Harde, 2023

Material legs: Oak

Colour legs: Light oiled oak, smoked oak finish or black painted oak

Materials seat, backrest and armrest: Plywood base, cold foam filling, textile cover

Price group 0: Cura (Gabriel)

Price group 1: Brusvik, Reflect (Kvadrat)

Price group 2: Remix 3, Atlas (Kvadrat)

Price group 3: Steelcut Trio 3, Fiord 2, Canvas 2 (Kvadrat)

Price group 4: Vidar, Moss (Kvadrat)

Net weight: 32.0 kg

Minimum order size: 1

Made to order

Dimensions (cm):

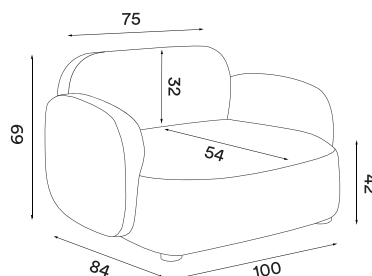

Prices NOK	(RRP ex. VAT)	(RRP incl. VAT)
Price group 0	15 992,-	19 990,-
Price group 1	18 392,-	22 990,-
Price group 2	19 992,-	24 990,-
Price group 3	22 392,-	27 990,-
Price group 4	23 992,-	29 990,-

Prices DKK	(RRP ex. VAT)	(RRP incl. VAT)
Price group 0	12 392,-	15 490,-
Price group 1	14 392,-	17 990,-
Price group 2	15 592,-	19 490,-
Price group 3	17 592,-	21 990,-
Price group 4	19 992,-	23 990,-

Prices SEK	(RRP ex. VAT)	(RRP incl. VAT)
Price group 0	17 592,-	21 990,-
Price group 1	19 992,-	24 990,-
Price group 2	21 592,-	26 990,-
Price group 3	24 792,-	30 990,-
Price group 4	26 392,-	32 990,-

Prices Euro	(RRP ex. VAT)	(RRP incl. VAT)
Price group 0	1 666,-	1 999,-
Price group 1	1 916,-	2 299,-
Price group 2	2 083,-	2 499,-
Price group 3	2 333,-	2 799,-
Price group 4	2 499,-	2 999,-





Gem pouf price group 0 – *Item no. 2750*

Gem pouf price group 1 – *Item no. 2751*

Gem pouf price group 2 – *Item no. 2752*

Gem pouf price group 3 – *Item no. 2753*

Gem pouf price group 4 – *Item no. 2754*

Product type: Pouf

Design: Meike Harde, 2023

Material legs: Oak

Colour legs: Light oiled oak, smoked oak finish or black painted oak

Materials: Plywood base, cold foam filling, textile cover

Price group 0: Cura (Gabriel)

Price group 1: Brusvik, Reflect (Kvadrat)

Price group 2: Remix 3, Atlas (Kvadrat)

Price group 3: Steelcut Trio 3, Fiord 2, Canvas 2 (Kvadrat)

Price group 4: Vidar, Moss (Kvadrat)

Net weight: 12.0 kg

Minimum order size: 1

Made to order

Dimensions (cm):

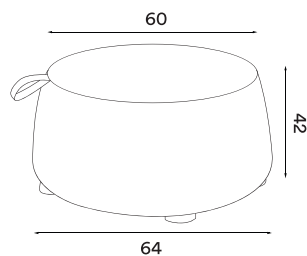

Prices NOK	(RRP ex. VAT)	(RRP incl. VAT)
Price group 0	7 992,-	9 990,-
Price group 1	9 592,-	11 990,-
Price group 2	10 392,-	12 990,-
Price group 3	11 992,-	14 990,-
Price group 4	12 792,-	15 990,-

Prices DKK	(RRP ex. VAT)	(RRP incl. VAT)
Price group 0	6 392,-	7 990,-
Price group 1	7 992,-	9 990,-
Price group 2	8 792,-	10 990,-
Price group 3	10 392,-	12 990,-
Price group 4	11 192,-	13 990,-

Prices SEK	(RRP ex. VAT)	(RRP incl. VAT)
Price group 0	8 792,-	10 990,-
Price group 1	10 392,-	12 990,-
Price group 2	11 592,-	14 490,-
Price group 3	13 192,-	16 490,-
Price group 4	13 992,-	17 490,-

Prices Euro	(RRP ex. VAT)	(RRP incl. VAT)
Price group 0	833,-	999,-
Price group 1	999,-	1199,-
Price group 2	1083,-	1299,-
Price group 3	1249,-	1499,-
Price group 4	1333,-	1599,-



Gem sofa 3 seater

P. 23



Gem sofa 3 seater price group 0 – *Item no. 2250*

Gem sofa 3 seater price group 1 – *Item no. 2251*

Gem sofa 3 seater price group 2 – *Item no. 2252*

Gem sofa 3 seater price group 3 – *Item no. 2253*

Gem sofa 3 seater price group 4 – *Item no. 2254*

Product type: Sofa

Design: Meike Harde, 2022

Material legs: Oak

Colour legs: Light oiled oak, smoked oak finish or black painted oak

Materials seat, backrest and armrest: Plywood base, cold foam filling, textile cover

Price group 0: Cura (Gabriel)

Price group 1: Brusvik, Reflect (Kvadrat)

Price group 2: Remix 3, Atlas (Kvadrat)

Price group 3: Steelcut Trio 3, Fiord 2, Canvas 2 (Kvadrat)

Price group 4: Vidar, Moss (Kvadrat)

Net weight: 63.0 kg

Minimum order size: 1

Made to order

Dimensions (cm):

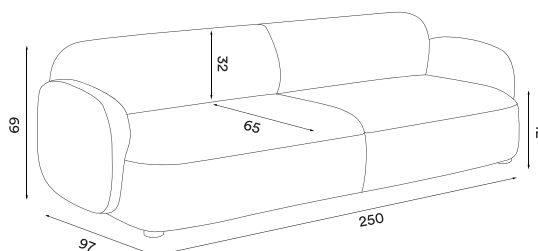

Prices NOK	(RRP ex. VAT)	(RRP incl. VAT)
Price group 0	31 992,-	39 990,-
Price group 1	35 992,-	44 990,-
Price group 2	39 192,-	48 990,-
Price group 3	43 992,-	54 990,-
Price group 4	47 992,-	59 990,-

Prices DKK	(RRP ex. VAT)	(RRP incl. VAT)
Price group 0	26 392,-	32 990,-
Price group 1	29 592,-	36 990,-
Price group 2	31 992,-	39 990,-
Price group 3	35 992,-	44 990,-
Price group 4	38 392,-	47 990,-

Prices SEK	(RRP ex. VAT)	(RRP incl. VAT)
Price group 0	35 192,-	43 990,-
Price group 1	39 192,-	48 990,-
Price group 2	42 392,-	52 990,-
Price group 3	47 992,-	59 990,-
Price group 4	51 192,-	63 990,-

Prices Euro	(RRP ex. VAT)	(RRP incl. VAT)
Price group 0	3 666,-	4 399,-
Price group 1	4 083,-	4 899,-
Price group 2	4 416,-	5 299,-
Price group 3	4 999,-	5 999,-
Price group 4	5 416,-	6 499,-



Hifive glass cabinet

P. 24

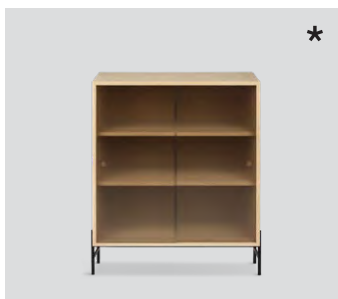

Hifive glass cabinet 75H74
light oak H15 legs

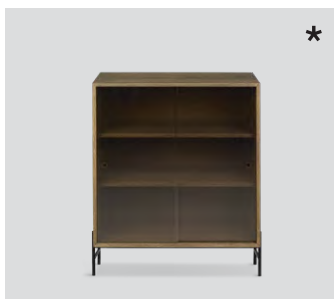

Hifive glass cabinet 75H74
smoked oak H15 legs

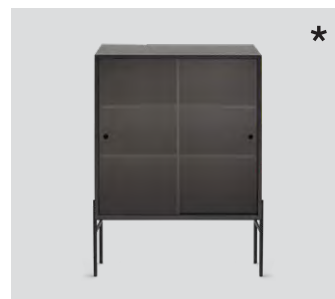

Hifive glass cabinet 75H74
black oak H28 legs

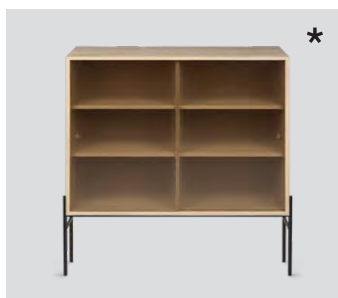

Hifive glass cabinet 100H74
light oak H28 legs

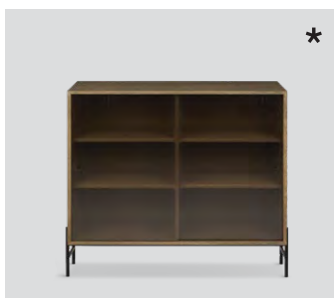

Hifive glass cabinet 100H74
smoked oak H15 legs



Hifive glass cabinet 75H74
black oak H15 legs

Product type: Glass cabinet
Design: Rudi Wulff, 2018 / 2023
Material cabinets: MDF, oak veneer
Colour cabinets: Light oiled oak, smoked oak finish
 or black painted oak
Material doors: Tempered glass (fluted)
Colour doors: Bronze tinted
Material legs: Steel
Colour legs: Black (Ral 9005)

Dimensions (cm):

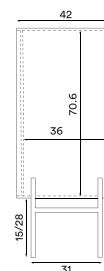

Net weight 75 cm cabinet: 27.5 kg
Net weight 100 cm cabinet: 39.5 kg

Net weight legs 75 cm: 2.2 kg / 2.4 kg
Net weight legs 100 cm: 2.4 kg / 2.6 kg

Minimum order size: 1

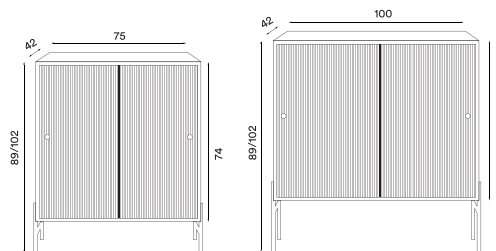

Prices NOK	(RRP ex. VAT)	(RRP incl. VAT)	Prices SEK	(RRP ex. VAT)	(RRP incl. VAT)
Hifive glass cabinet 75	15 920,-	19 900,-	Hifive glass cabinet 75	17 520,-	21 900,-
Hifive glass cabinet 100	19 920,-	24 900,-	Hifive glass cabinet 100	22 000,-	27 500,-

Prices DKK	(RRP ex. VAT)	(RRP incl. VAT)	Prices Euro	(RRP ex. VAT)	(RRP incl. VAT)
Hifive glass cabinet 75	12 400,-	15 500,-	Hifive glass cabinet 75	1 658,-	1 990,-
Hifive glass cabinet 100	15 600,-	19 500,-	Hifive glass cabinet 100	2 075,-	2 490,-



Hifive glass cabinet components

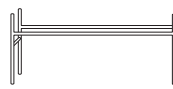
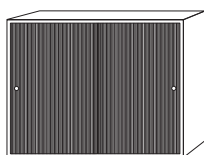
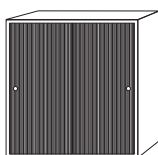

Glass cabinet 75

Glass cabinet 100

Legs H15 (low)

Legs H28 (high)

Light oiled oak
– Item no. 2350

Light oiled oak
– Item no. 2360

75 cm
– Item no. 2053

75 cm
– Item no. 2041

Smoked oak
– Item no. 2351

Smoked oak
– Item no. 2361

100 cm
– Item no. 2055

100 cm
– Item no. 2051

Black painted oak
– Item no. 2352

Black painted oak
– Item no. 2362

Prices NOK (RRP ex. VAT) (RRP incl. VAT)

Glass cabinet 75 cm	13 360,-	16 700,-
Glass cabinet 100 cm	16 800,-	21 000,-
Legs 75 cm	2 560,-	3 200,-
Legs 100 cm	3 120,-	3 900,-

Prices SEK (RRP ex. VAT) (RRP incl. VAT)

Glass cabinet 75 cm	14 720,-	18 400,-
Glass cabinet 100 cm	18 640,-	23 300,-
Legs 75 cm	2 800,-	3 500,-
Legs 100 cm	3 360,-	4 200,-

Prices DKK (RRP ex. VAT) (RRP incl. VAT)

Glass cabinet 75 cm	10 400,-	13 000,-
Glass cabinet 100 cm	13 200,-	16 500,-
Legs 75 cm	2 000,-	2 500,-
Legs 100 cm	2 400,-	3 000,-

Prices Euro (RRP ex. VAT) (RRP incl. VAT)

Glass cabinet 75 cm	1 367,-	1 640,-
Glass cabinet 100 cm	1 758,-	2 110,-
Legs 75 cm	280,-	350,-
Legs 100 cm	304,-	380,-



Hifive glass storage system



Hifive glass 75 light oak floor H15



Hifive glass 75 smoked oak wall



Hifive 75 black oak floor H28



Hifive glass 100 light oak floor H28



Hifive glass 100 smoked oak floor H15



Hifive glass 100 black oak wall



Hifive glass 150 light oak wall



Hifive glass 150 smoked oak floor H28



Hifive glass 150 black oak floor H15



Hifive glass 200 light oak floor H15



Hifive glass 200 smoked oak floor H28



Hifive glass 200 black oak wall

Hifive glass storage system

P. 27

Product type: Media furniture / storage

Design: Rudi Wulff, 2018 / 2023

Material cabinet boxes and top board: MDF, oak veneer

Colour cabinet boxes and top board: Light oiled oak, smoked oak finish or black painted oak

Material legs: Steel

Colour legs: Black (Ral9005)

Net weight glass box 75 cm: 19.0 kg

Net weight glass box 100 cm: 27.0 kg

Net weight top/back board 150 cm: 4.2 kg

Net weight top/back board 200 cm: 6.4 kg

Net weight legs 75 cm: 2.2 kg / 2.4 kg

Net weight legs 100 cm: 2.4 kg / 2.6 kg

Net weight legs 150 cm: 3.8 kg / 4.1 kg

Net weight legs 200 cm: 4.2 kg / 4.5 kg

Minimum order size: 1

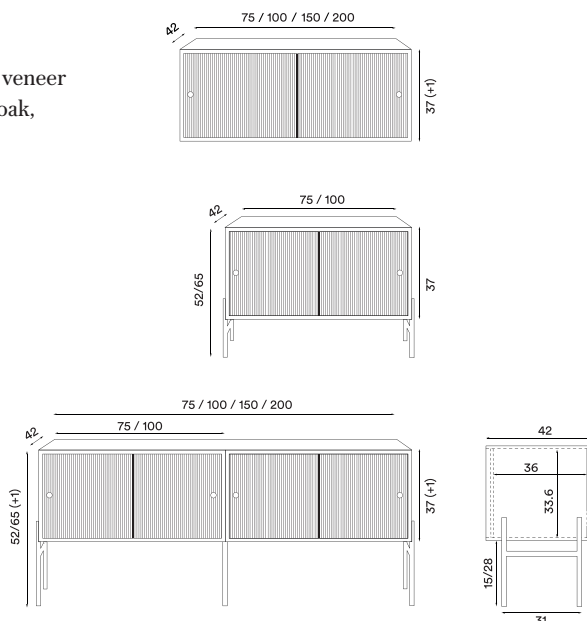

Prices NOK	(RRP ex. VAT)	(RRP incl. VAT)
Hifive glass 75 wall	9 280,-	11 600,-
Hifive glass 75 floor	11 840,-	14 800,-
Hifive glass 100 wall	12 080,-	15 100,-
Hifive glass 100 floor	15 200,-	19 000,-

Prices NOK	(RRP ex. VAT)	(RRP incl. VAT)
Hifive glass 150 wall	21 592,-	26 990,-
Hifive glass 150 floor	25 752,-	32 190,-
Hifive glass 200 wall	27 432,-	34 290,-
Hifive glass 200 floor	31 992,-	39 990,-

Prices SEK	(RRP ex. VAT)	(RRP incl. VAT)
Hifive glass 75 wall	10 320,-	12 900,-
Hifive glass 75 floor	13 120,-	16 400,-
Hifive glass 100 wall	13 280,-	16 600,-
Hifive glass 100 floor	16 640,-	20 800,-

Prices SEK	(RRP ex. VAT)	(RRP incl. VAT)
Hifive glass 150 wall	23 992,-	29 990,-
Hifive glass 150 floor	28 552,-	35 690,-
Hifive glass 200 wall	30 312,-	37 890,-
Hifive glass 200 floor	35 512,-	44 390,-

Prices DKK	(RRP ex. VAT)	(RRP incl. VAT)
Hifive glass 75 wall	7 120,-	8 900,-
Hifive glass 75 floor	9 120,-	11 400,-
Hifive glass 100 wall	9 360,-	11 700,-
Hifive glass 100 floor	11 600,-	14 500,-

Prices DKK	(RRP ex. VAT)	(RRP incl. VAT)
Hifive glass 150 wall	16 632,-	20 790,-
Hifive glass 150 floor	19 752,-	24 690,-
Hifive glass 200 wall	21 192,-	26 490,-
Hifive glass 200 floor	24 792,-	30 990,-

Prices Euro	(RRP ex. VAT)	(RRP incl. VAT)
Hifive glass 75 wall	1 017,-	1 220,-
Hifive glass 75 floor	1 308,-	1 570,-
Hifive glass 100 wall	1 250,-	1 500,-
Hifive glass 100 floor	1 567,-	1 880,-

Prices Euro	(RRP ex. VAT)	(RRP incl. VAT)
Hifive glass 150 wall	2 333,-	2 799,-
Hifive glass 150 floor	2 791,-	3 349,-
Hifive glass 200 wall	2 824,-	3 389,-
Hifive glass 200 floor	3 324,-	3 989,-



Hifive glass storage system components P. 28

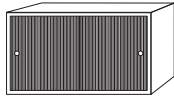

Glass box 75 cm

Light oiled oak
- *Item no. 2330*

Smoked oak
- *Item no. 2331*

Black painted oak
- *Item no. 2332*

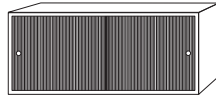

Glass box 100 cm

Light oiled oak
- *Item no. 2340*

Smoked oak
- *Item no. 2341*

Black painted oak
- *Item no. 2342*

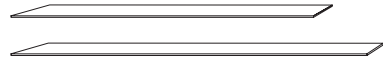

Top board 150 cm

Light oiled oak
- *Item no. 2271*

Smoked oak
- *Item no. 2272*

Black painted oak
- *Item no. 2273*

Top board 200 cm

Light oiled oak
- *Item no. 2281*

Smoked oak
- *Item no. 2282*

Black painted oak
- *Item no. 2283*



Legs H15 (low)

75 cm
- *Item no. 2053*

100 cm
- *Item no. 2055*

150 cm
- *Item no. 2054*

200 cm
- *Item no. 2056*

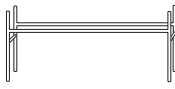

Legs H28 (high)

75 cm
- *Item no. 2041*

100 cm
- *Item no. 2051*

150 cm
- *Item no. 2042*

200 cm
- *Item no. 2052*



+ Sold as optional addition



Back board 150 cm

Light oiled oak
- *Item no. 2416*

Smoked oak
- *Item no. 2417*

Black painted oak
- *Item no. 2418*

Back board 200 cm

Light oiled oak
- *Item no. 2413*

Smoked oak
- *Item no. 2414*

Black painted oak
- *Item no. 2415*





Prices NOK	(RRP ex. VAT)	(RRP incl. VAT)
Glass box 75 cm	9 280,-	11 600,-
Glass box 100 cm	12 080,-	15 100,-
Top/back board 150	3 032,-	3 790,-
Top/back board 200	3 272,-	4 090,-

Prices NOK	(RRP ex. VAT)	(RRP incl. VAT)
Legs 75 cm	2 560,-	3 200,-
Legs 100 cm	3 120,-	3 900,-
Legs 150 cm	4 160,-	5 200,-
Legs 200 cm	4 560,-	5 700,-

Prices SEK	(RRP ex. VAT)	(RRP incl. VAT)
Glass box 75 cm	10 320,-	12 900,-
Glass box 100 cm	13 280,-	16 600,-
Top/back board 150	3 352,-	4 190,-
Top/back board 200	3 752,-	4 690,-

Prices SEK	(RRP ex. VAT)	(RRP incl. VAT)
Legs 75 cm	2 800,-	3 500,-
Legs 100 cm	3 360,-	4 200,-
Legs 150 cm	4 560,-	5 700,-
Legs 200 cm	5 200,-	6 500,-

Prices DKK	(RRP ex. VAT)	(RRP incl. VAT)
Glass box 75 cm	7 120,-	8 900,-
Glass box 100 cm	9 360,-	11 700,-
Top/back board 150	2 392,-	2 990,-
Top/back board 200	2 472,-	3 090,-

Prices DKK	(RRP ex. VAT)	(RRP incl. VAT)
Legs 75 cm	2 000,-	2 500,-
Legs 100 cm	2 400,-	3 000,-
Legs 150 cm	3 120,-	3 900,-
Legs 200 cm	3 600,-	4 500,-

Prices Euro	(RRP ex. VAT)	(RRP incl. VAT)
Glass box 75 cm	1 017,-	1 220,-
Glass box 100 cm	1 250,-	1 500,-
Top/back board 150	299,-	359,-
Top/back board 200	324,-	389,-

Prices Euro	(RRP ex. VAT)	(RRP incl. VAT)
Legs 75 cm	280,-	350,-
Legs 100 cm	304,-	380,-
Legs 150 cm	440,-	550,-
Legs 200 cm	500,-	600,-



Hifive storage system

P. 30

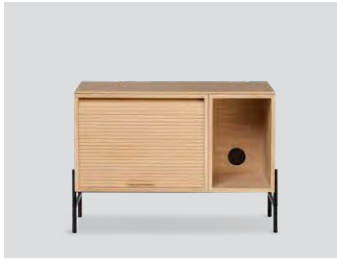

Hifive 75 light oak floor H15

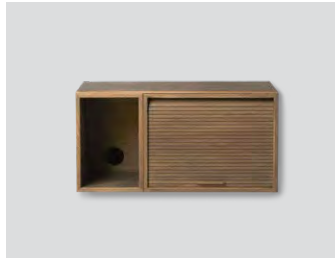

Hifive 75 smoked oak wall



Hifive 75 black oak floor H28

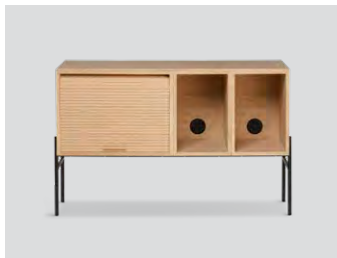

Hifive 100 light oak floor H28



Hifive 100 smoked oak floor H15



Hifive 100 black oak wall

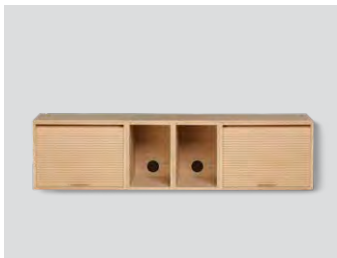

Hifive 150 light oak wall



Hifive 150 smoked oak floor H28



Hifive 150 black oak floor H15

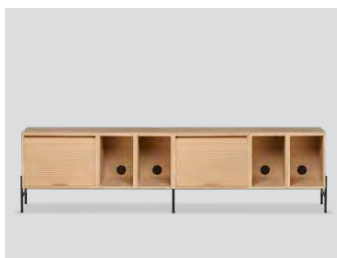

Hifive 200 light oak floor H15



Hifive 200 smoked oak floor H28

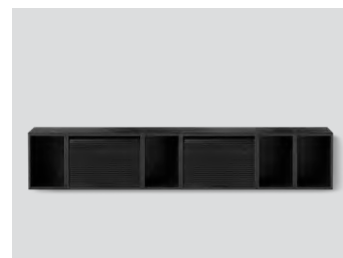

Hifive 200 black oak wall

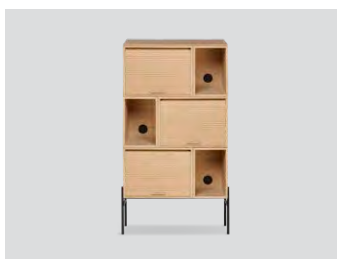

Hifive 75 x 114 tall cabinet
light oak floor H28

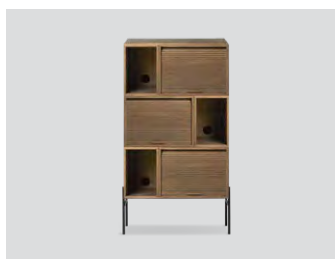

Hifive 75 x 114 tall cabinet
smoked oak floor H28



Hifive 75 x 114 tall cabinet
black painted oak floor H28



Hifive storage system

P. 31

Product type: Media furniture / storage

Design: Rudi Wulff, 2018

Material cabinet boxes and top board: MDF, oak veneer

Colour cabinet boxes and top board: Light oiled oak, smoked oak finish or black painted oak

Material legs: Steel

Colour legs: Black (Ral9005)

Net weight open box (25 cm): 6.4 kg

Net weight tambour cabinet (50 cm): 12.5 kg

Net weight top/back board 75 cm: 2.1 kg

Net weight top/back board 100 cm: 3.2 kg

Net weight top/back board 150 cm: 4.2 kg

Net weight top/back board 200 cm: 6.4 kg

Net weight legs 75 cm: 2.2 kg / 2.4 kg

Net weight legs 100 cm: 2.4 kg / 2.6 kg

Net weight legs 150 cm: 3.8 kg / 4.1 kg

Net weight legs 200 cm: 4.2 kg / 4.5 kg

Minimum order size: 1

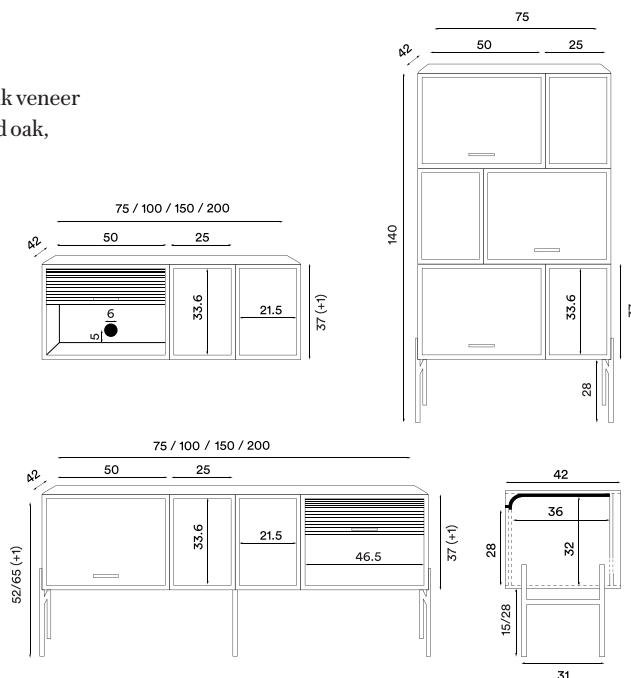

Prices NOK	(RRP ex. VAT)	(RRP incl. VAT)
Hifive 75 wall	10 152,-	12 690,-
Hifive 75 floor	12 712,-	15 890,-
Hifive 100 wall	13 592,-	16 990,-
Hifive 100 floor	16 712,-	20 890,-

Prices NOK	(RRP ex. VAT)	(RRP incl. VAT)
Hifive 150 wall	20 152,-	25 190,-
Hifive 150 floor	24 312,-	30 390,-
Hifive 200 wall	26 312,-	32 890,-
Hifive 200 floor	30 872,-	38 590,-
Hifive 75 tall floor	29 832,-	37 290,-

Prices SEK	(RRP ex. VAT)	(RRP incl. VAT)
Hifive 75 wall	11 192,-	13 990,-
Hifive 75 floor	13 992,-	17 490,-
Hifive 100 wall	15 032,-	18 790,-
Hifive 100 floor	18 392,-	22 990,-

Prices SEK	(RRP ex. VAT)	(RRP incl. VAT)
Hifive 150 wall	22 232,-	27 790,-
Hifive 150 floor	26 792,-	33 490,-
Hifive 200 wall	28 792,-	35 990,-
Hifive 200 floor	33 992,-	42 490,-
Hifive 75 tall floor	32 792,-	40 990,-

Prices DKK	(RRP ex. VAT)	(RRP incl. VAT)
Hifive 75 wall	7 992,-	9 990,-
Hifive 75 floor	9 992,-	12 490,-
Hifive 100 wall	10 392,-	12 990,-
Hifive 100 floor	12 792,-	15 990,-

Prices DKK	(RRP ex. VAT)	(RRP incl. VAT)
Hifive 150 wall	15 832,-	19 790,-
Hifive 150 floor	18 952,-	23 690,-
Hifive 200 wall	20 392,-	25 490,-
Hifive 200 floor	23 992,-	29 990,-
Hifive 75 tall floor	23 432,-	29 290,-

Prices Euro	(RRP ex. VAT)	(RRP incl. VAT)
Hifive 75 wall	1 083,-	1 299,-
Hifive 75 floor	1 374,-	1 649,-
Hifive 100 wall	1 449,-	1 739,-
Hifive 100 floor	1 766,-	2 119,-

Prices Euro	(RRP ex. VAT)	(RRP incl. VAT)
Hifive 150 wall	2 166,-	2 599,-
Hifive 150 floor	2 624,-	3 149,-
Hifive 200 wall	2 808,-	3 369,-
Hifive 200 floor	3 308,-	3 969,-
Hifive 75 tall floor	3 241,-	3 889,-



Hifive storage system components

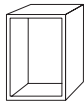

Open box

Light oiled oak
- Item no. 2062

Smoked oak
- Item no. 2061

Black painted oak
- Item no. 2063

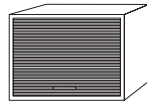

Tambour cabinet

Light oiled oak
- Item no. 2072

Smoked oak
- Item no. 2071

Black painted oak
- Item no. 2073

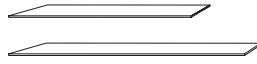

Top board 75 cm

Light oiled oak
- Item no. 2081

Smoked oak
- Item no. 2082

Black painted oak
- Item no. 2083

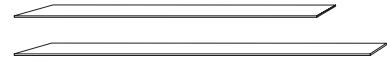

Top board 100 cm

Light oiled oak
- Item no. 2091

Smoked oak
- Item no. 2092

Black painted oak
- Item no. 2093

Top board 150 cm

Light oiled oak
- Item no. 2271

Smoked oak
- Item no. 2272

Black painted oak
- Item no. 2273

Top board 200 cm

Light oiled oak
- Item no. 2281

Smoked oak
- Item no. 2282

Black painted oak
- Item no. 2283



Legs H15 (low)

75 cm
- Item no. 2053

100 cm
- Item no. 2055

150 cm
- Item no. 2054

200 cm
- Item no. 2056



Legs H28 (high)

75 cm
- Item no. 2041

100 cm
- Item no. 2051

150 cm
- Item no. 2042

200 cm
- Item no. 2052

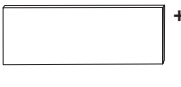

Back board 75 cm

Light oiled oak
- Item no. 2407

Smoked oak
- Item no. 2408

Black painted oak
- Item no. 2409

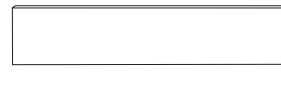

Back board 100 cm

Light oiled oak
- Item no. 2404

Smoked oak
- Item no. 2405

Black painted oak
- Item no. 2406

+ Sold as optional addition

Back board 150 cm

Light oiled oak
- Item no. 2416

Smoked oak
- Item no. 2417

Black painted oak
- Item no. 2418

Back board 200 cm

Light oiled oak
- Item no. 2413

Smoked oak
- Item no. 2414

Black painted oak
- Item no. 2415





Prices NOK	(RRP ex. VAT)	(RRP incl. VAT)
Open box	2 960,-	3 700,-
Tambour cabinet	5 600,-	7 000,-
Top/back board 75	1 592,-	1 990,-
Top/back board 100	2 072,-	2 590,-
Top/back board 150	3 032,-	3 790,-

Prices NOK	(RRP ex. VAT)	(RRP incl. VAT)
Top/back board 200	3 272,-	4 090,-
Legs 75 cm	2 560,-	3 200,-
Legs 100 cm	3 120,-	3 900,-
Legs 150 cm	4 160,-	5 200,-
Legs 200 cm	4 560,-	5 700,-

Prices SEK	(RRP ex. VAT)	(RRP incl. VAT)
Open box	3 280,-	4 100,-
Tambour cabinet	6 160,-	7 700,-
Top/back board 75	1 752,-	2 190,-
Top/back board 100	2 312,-	2 890,-
Top/back board 150	3 352,-	4 190,-

Prices SEK	(RRP ex. VAT)	(RRP incl. VAT)
Top/back board 200	3 752,-	4 690,-
Legs 75 cm	2 800,-	3 500,-
Legs 100 cm	3 360,-	4 200,-
Legs 150 cm	4 560,-	5 700,-
Legs 200 cm	5 200,-	6 500,-

Prices DKK	(RRP ex. VAT)	(RRP incl. VAT)
Open box	2 240,-	2 800,-
Tambour cabinet	4 480,-	5 600,-
Top/back board 75	1 272,-	1 590,-
Top/back board 100	1 432,-	1 790,-
Top/back board 150	2 392,-	2 990,-

Prices DKK	(RRP ex. VAT)	(RRP incl. VAT)
Top/back board 200	2 472,-	3 090,-
Legs 75 cm	2 000,-	2 500,-
Legs 100 cm	2 400,-	3 000,-
Legs 150 cm	3 120,-	3 900,-
Legs 200 cm	3 600,-	4 500,-

Prices Euro	(RRP ex. VAT)	(RRP incl. VAT)
Open box	308,-	370,-
Tambour cabinet	625,-	750,-
Top/back board 75	149,-	179,-
Top/back board 100	208,-	249,-
Top/back board 150	299,-	359,-

Prices Euro	(RRP ex. VAT)	(RRP incl. VAT)
Top/back board 200	324,-	389,-
Legs 75 cm	292,-	350,-
Legs 100 cm	317,-	380,-
Legs 150 cm	458,-	550,-
Legs 200 cm	500,-	600,-



Hifive slim wall

P. 34

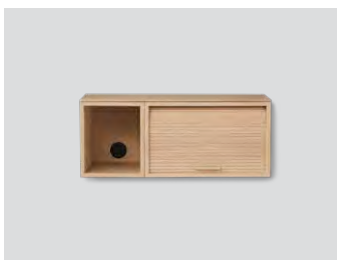

Hifive slim 75 light oak

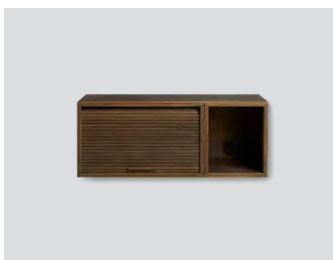

Hifive slim 75 smoked oak



Hifive slim 75 black oak

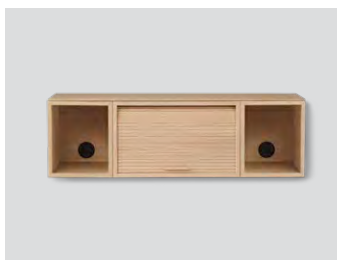

Hifive slim 100 light oak

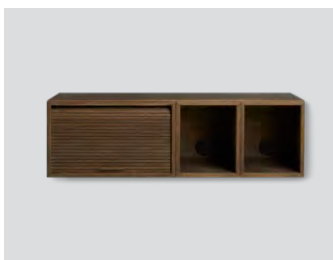

Hifive slim 100 smoked oak



Hifive slim 100 black oak

Product type: Media furniture / storage

Design: Rudi Wulff, 2019

Material cabinet boxes and top board: MDF, oak veneer

Colour cabinet boxes and top board: Light oiled oak, smoked oak finish or black painted oak

Net weight open box: 4.7 kg

Net weight tambour cabinet: 8.0 kg

Net weight top board 75 cm: 1.5 kg

Net weight top board 100 cm: 2.0 kg

Minimum order size: 1

Dimensions (cm):

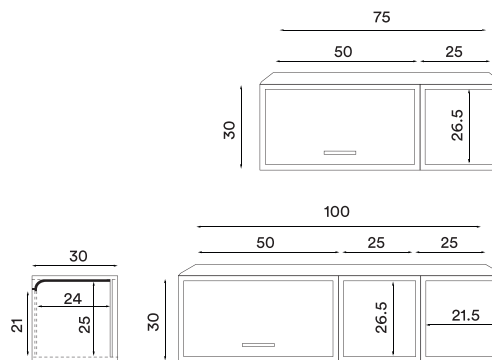

Prices NOK	(RRP ex. VAT)	(RRP incl. VAT)	Prices SEK	(RRP ex. VAT)	(RRP incl. VAT)
Hifive slim 75	7 512,-	9 390,-	Hifive slim 75	7 992,-	9 990,-
Hifive slim 100	10 392,-	12 990,-	Hifive slim 100	11 192,-	13 990,-

Prices DKK	(RRP ex. VAT)	(RRP incl. VAT)	Prices Euro	(RRP ex. VAT)	(RRP incl. VAT)
Hifive slim 75	5 752,-	7 190,-	Hifive slim 75	808,-	969,-
Hifive slim 100	7 832,-	9 790,-	Hifive slim 100	1 124,-	1 349,-



Hifive slim wall components

P. 35

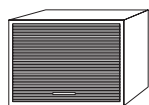
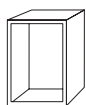

Open box

Light oiled oak
- Item no. 2292

Smoked oak
- Item no. 2291

Black painted oak
- Item no. 2293

Tambour cabinet

Light oiled oak
- Item no. 2302

Smoked oak
- Item no. 2301

Black painted oak
- Item no. 2303

Top board 75 cm

Light oiled oak
- Item no. 2311

Smoked oak
- Item no. 2312

Black painted oak
- Item no. 2313

Top board 100 cm

Light oiled oak
- Item no. 2321

Smoked oak
- Item no. 2322

Black painted oak
- Item no. 2323

Prices NOK

(RRP ex. VAT) (RRP incl. VAT)

Open box
Tambour cabinet
Top board 75 cm
Top board 100 cm

(RRP ex. VAT)	(RRP incl. VAT)
2 480,-	3 100,-
3 680,-	4 600,-
1 352,-	1 690,-
1 752,-	2 190,-

Prices SEK

(RRP ex. VAT) (RRP incl. VAT)

Open box
Tambour cabinet
Top board 75 cm
Top board 100 cm

(RRP ex. VAT)	(RRP incl. VAT)
2 640,-	3 300,-
3 920,-	4 900,-
1 432,-	1 790,-
1 992,-	2 490,-

Prices DKK

(RRP ex. VAT) (RRP incl. VAT)

Open box
Tambour cabinet
Top board 75 cm
Top board 100 cm

(RRP ex. VAT)	(RRP incl. VAT)
1 840,-	2 300,-
2 880,-	3 600,-
1 032,-	1 290,-
1 272,-	1 590,-

Prices Euro

(RRP ex. VAT) (RRP incl. VAT)

Open box
Tambour cabinet
Top board 75 cm
Top board 100 cm

(RRP ex. VAT)	(RRP incl. VAT)
267,-	320,-
400,-	480,-
141,-	169,-
191,-	229,-





Loud bar cabinet

P. 37



Loud bar cabinet light oiled oak – *Item no. 2189*



Loud bar cabinet smoked oak – *Item no. 2190*



Loud bar cabinet smoked oak / mirror – *Item no. 2192*



Loud bar cabinet black – *Item no. 2193*

Product type: Bar cabinet

Design: Färg & Blanche, 2018

Material legs, shelves and top: Solid oak

Material cabinet: Plywood, oak veneer or polished aluminium laminate (mirror/smoked oak version only)

Colours: Light oiled oak, smoked oak finish, mirror/smoked oak finish or black painted oak

Wheels: Steel with rubber

Net weight: 12.3 kg

Minimum order size: 1

Dimensions (cm):

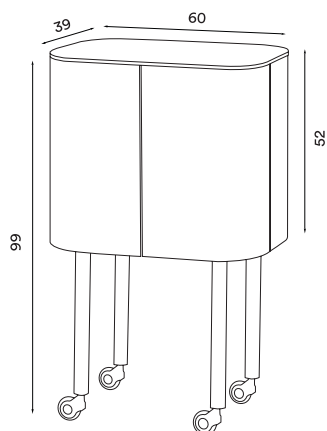

Prices NOK	(RRP ex. VAT)	(RRP incl. VAT)
	25 992,-	32 490,-

Prices SEK	(RRP ex. VAT)	(RRP incl. VAT)
	28 792,-	35 990,-

Prices DKK	(RRP ex. VAT)	(RRP incl. VAT)
	19 992,-	24 990,-

Prices Euro	(RRP ex. VAT)	(RRP incl. VAT)
	2 825,-	3 399,-



Loud tall cabinet

P. 38



Loud tall cabinet light oiled oak
– Item no. 2194



Loud tall cabinet smoked oak finish
– Item no. 2195



Loud tall cabinet black
– Item no. 2196

Product type: Cabinet

Design: Färg & Blanche, 2022

Material legs and top: Solid oak

Material cabinet: Plywood, oak veneer

Colours: Light oiled oak, smoked oak finish or black painted oak

Material shelves: Glass (tempered, bronze tinted)

Max load weight shelves: 25 kg (each shelf)

Net weight: 50 kg

Minimum order size: 1

Dimensions (cm):

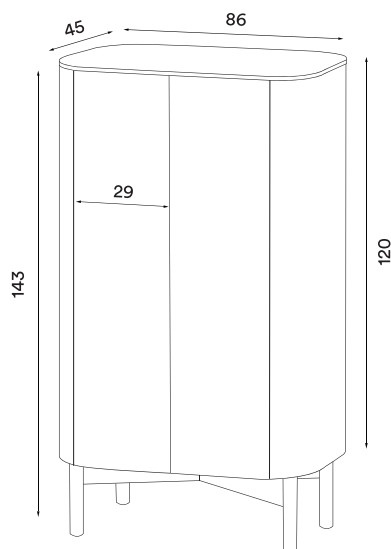

Prices NOK	(RRP ex. VAT)	(RRP incl. VAT)
Light / smoked oak	35 992,-	44 990,-
Black	39 192,-	48 990,-

Prices SEK	(RRP ex. VAT)	(RRP incl. VAT)
Light / smoked oak	39 192,-	48 990,-
Black	42 392,-	52 990,-

Prices DKK	(RRP ex. VAT)	(RRP incl. VAT)
Light / smoked oak	29 592,-	36 990,-
Black	31 992,-	39 990,-

Prices Euro	(RRP ex. VAT)	(RRP incl. VAT)
Light / smoked oak	4 083,-	4 899,-
Black	4 416,-	5 299,-



Loud sideboard cabinet

P. 39



Loud sideboard light oiled oak – *Item no. 2197*



Loud sideboard smoked oak finish – *Item no. 2198*



Loud sideboard black – *Item no. 2199*

Product type: Sideboard

Design: Färg & Blanche, 2022

Material legs and top: Solid oak

Material cabinet: Plywood, oak veneer

Colours: Light oiled oak, smoked oak finish or black painted oak

Material shelves: Glass (tempered, bronze tinted)

Max load weight shelves: 25 kg (each shelf)

Net weight: 50 kg

Minimum order size: 1

Dimensions (cm):

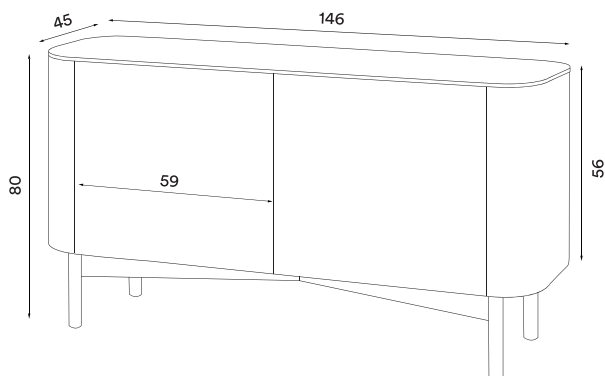

Prices NOK	(RRP ex. VAT)	(RRP incl. VAT)
Light / smoked oak	35 992,-	44 990,-
Black	39 192,-	48 990,-

Prices DKK	(RRP ex. VAT)	(RRP incl. VAT)
Light / smoked oak	29 592,-	36 990,-
Black	31 992,-	39 990,-

Prices SEK	(RRP ex. VAT)	(RRP incl. VAT)
Light / smoked oak	39 192,-	48 990,-
Black	42 392,-	52 990,-

Prices Euro	(RRP ex. VAT)	(RRP incl. VAT)
Light / smoked oak	4 083,-	4 899,-
Black	4 416,-	5 299,-



Mass side table

P. 40



Mass table black
– Item no. 2401



Mass table steel
– Item no. 2402



Mass table brass
– Item no. 2403

Product type: Side table

Design: Roeë Magdassi, 2020

Material: Steel (black and steel versions),
solid brass (brass version)

Colours: Black, brushed steel or brushed brass

Net weight (black and steel): 5.9 kg

Net weight (brass): 6.3 kg

Minimum order size: 1

Dimensions (cm):

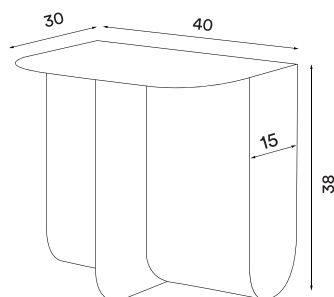

Prices NOK	(RRP ex. VAT)	(RRP incl. VAT)
Black	3 992,-	4 990,-
Steel	4 792,-	5 990,-
Brass	7 992,-	9 990,-

Prices DKK	(RRP ex. VAT)	(RRP incl. VAT)
Black	3 192,-	3 990,-
Steel	3 832,-	4 790,-
Brass	6 392,-	7 990,-

Prices SEK	(RRP ex. VAT)	(RRP incl. VAT)
Black	4 392,-	5 490,-
Steel	5 272,-	6 590,-
Brass	8 792,-	10 990,-

Prices Euro	(RRP ex. VAT)	(RRP incl. VAT)
Black	458,-	549,-
Steel	541,-	649,-
Brass	916,-	1 099,-



Oaki dining chair

P. 41



Oaki light oak – Item no. 2111



Oaki smoked oak – Item no. 2112



Oaki black oak – Item no. 2113



Oaki light oak w/seat padding
– Item no. 2118



Oaki smoked oak w/seat padding
– Item no. 2116



Oaki black oak w/seat padding
– Item no. 2117

Product type: Dining chair

Design: Stine Aas, 2018

Material body: Solid oak

Material seat and backrest: Laminated oak veneer

Colours body, seat and backrest: Light oiled oak, smoked oak finish or black painted oak

Material seat padding: Leather (Ultra from Sørensen)

Colour seat padding: Camel (41571) (light oak version only), Chocolate (41589) (smoked oak version only) or Black (41599) (black version only)

Net weight (no padding): 4.9 kg

Net weight (with seat padding): 5.4 kg

Minimum order size: 1

Dimensions (cm):

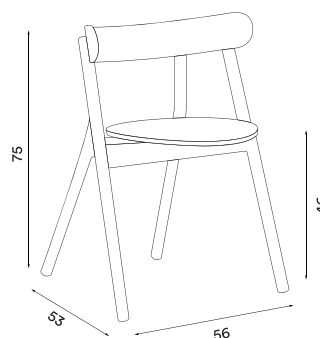

Prices NOK	(RRP ex. VAT)	(RRP incl. VAT)
Light/smoked oak	5 032,-	6 290,-
Black	5 192,-	6 490,-
Light/smoked oak w/seat padding	7 592,-	9 490,-
Black w/seat padding	7 752,-	9 690,-

Prices SEK	(RRP ex. VAT)	(RRP incl. VAT)
Light/smoked oak	5 592,-	6 990,-
Black	5 752,-	7 190,-
Light/smoked oak w/seat padding	8 392,-	10 490,-
Black w/seat padding	8 552,-	10 690,-

Prices DKK	(RRP ex. VAT)	(RRP incl. VAT)
Light/smoked oak	3 912,-	4 890,-
Black	4 072,-	5 090,-
Light/smoked oak w/seat padding	5 992,-	7 490,-
Black w/seat padding	6 072,-	7 590,-

Prices Euro	(RRP ex. VAT)	(RRP incl. VAT)
Light/smoked oak	541,-	649,-
Black	566,-	679,-
Light/smoked oak w/seat padding	833,-	999,-
Black w/seat padding	833,-	999,-



Oaki lounge chair with seat padding

P. 42



Oaki lounge chair light oak with seat padding
– Item no. 2423



Oaki lounge chair smoked oak with seat padding
– Item no. 2421

Product type: Lounge chair
Design: Stine Aas, 2020
Material body: Solid oak
Material seat and backrest: Laminated oak veneer
Colours body, seat and backrest: Light oiled oak or smoked oak finish
Material seat padding: Leather (Ultra from Sørensen)
Colour seat padding: Camel (41571) (light oak version only) or Chocolate (41589) (smoked oak version only)
Net weight: 9.6 kg
Minimum order size: 1

Dimensions (cm):

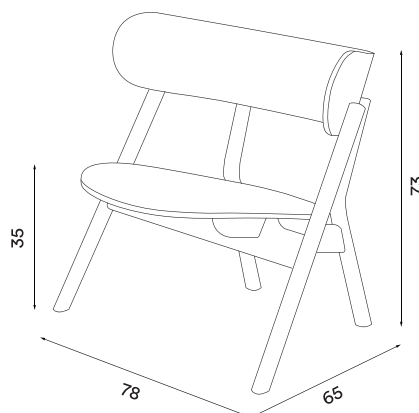

Prices NOK	(RRP ex. VAT)	(RRP incl. VAT)
	11 592,-	14 490,-

Prices SEK	(RRP ex. VAT)	(RRP incl. VAT)
	12 792,-	15 990,-

Prices DKK	(RRP ex. VAT)	(RRP incl. VAT)
	9 192,-	11 490,-

Prices Euro	(RRP ex. VAT)	(RRP incl. VAT)
	1 249,-	1 499,-



Oaki lounge chair with seat/back padding P. 43



Oaki lounge chair black painted oak with seat and back padding
 – Item no. 2432

Product type: Lounge chair
Design: Stine Aas, 2020
Material body: Solid oak
Material seat and backrest: Laminated oak veneer
Colours body, seat and backrest: Black painted oak
Material seat and back padding: Leather (Ultra from Sørensen)
Colour seat and back padding: Black (41599)
Net weight: 10.2 kg
Minimum order size: 1

Dimensions (cm):

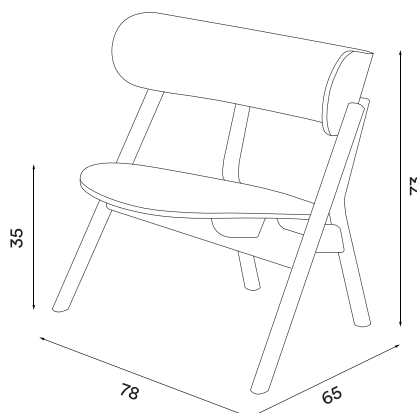

Prices NOK	(RRP ex. VAT)	(RRP incl. VAT)	Prices SEK	(RRP ex. VAT)	(RRP incl. VAT)
	13 592,-	16 990,-		15 192,-	18 990,-

Prices DKK	(RRP ex. VAT)	(RRP incl. VAT)	Prices Euro	(RRP ex. VAT)	(RRP incl. VAT)
	10 792,-	13 490,-		1 499,-	1 799,-



Oblong lounge chair

P. 44



Oblong chair price group 0 – *Item no. 2094*

Oblong chair price group 1 – *Item no. 2101*

Oblong chair price group 2 – *Item no. 2102*

Oblong chair price group 3 – *Item no. 2103*

Oblong chair price group 4 – *Item no. 2095*

Product type: Lounge chair

Design: Mario Tsai, 2018

Material legs: Steel

Colour legs: Black (Ral 9005)

Materials seat and backrest: Plywood base,

cold foam filling, textile cover

Price group 0: Cura (Gabriel)

Price group 1: Brusvik, Reflect (Kvadrat)

Price group 2: Remix 3, Atlas (Kvadrat)

Price group 3: Steelcut Trio 3, Fiord 2, Canvas 2 (Kvadrat)

Price group 4: Vidar, Moss (Kvadrat)

Net weight: 14.2 kg

Minimum order size: 1

Made to order

Dimensions (cm):

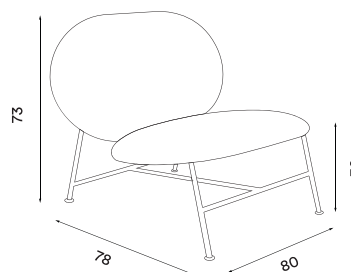

Prices NOK	(RRP ex. VAT)	(RRP incl. VAT)
Price group 0	9 592,-	11 990,-
Price group 1	11 992,-	14 990,-
Price group 2	12 792,-	15 990,-
Price group 3	13 592,-	16 990,-
Price group 4	14 392,-	17 990,-

Prices DKK	(RRP ex. VAT)	(RRP incl. VAT)
Price group 0	7 992,-	9 990,-
Price group 1	9 592,-	11 990,-
Price group 2	9 992,-	12 490,-
Price group 3	10 792,-	13 490,-
Price group 4	11 192,-	13 990,-

Prices SEK	(RRP ex. VAT)	(RRP incl. VAT)
Price group 0	10 392,-	12 990,-
Price group 1	12 792,-	15 990,-
Price group 2	14 392,-	17 990,-
Price group 3	15 192,-	18 990,-
Price group 4	15 992,-	19 990,-

Prices Euro	(RRP ex. VAT)	(RRP incl. VAT)
Price group 0	1 083,-	1 299,-
Price group 1	1 291,-	1 549,-
Price group 2	1 374,-	1 649,-
Price group 3	1 458,-	1 749,-
Price group 4	1 583,-	1 899,-





Oblong sofa price group 0 – *Item no. 2096*
 Oblong sofa price group 1 – *Item no. 2106*
 Oblong sofa price group 2 – *Item no. 2107*

Oblong sofa price group 3 – *Item no. 2108*
 Oblong sofa price group 4 – *Item no. 2097*

Product type: Sofa

Design: Mario Tsai, 2018

Material legs: Steel

Colour legs: Black (Ral 9005)

Materials seat and backrest: Plywood base, cold foam filling, textile cover

Price group 0: Cura (Gabriel)

Price group 1: Brusvik, Reflect (Kvadrat)

Price group 2: Remix 3, Atlas (Kvadrat)

Price group 3: Steelcut Trio 3, Fiord 2, Canvas 2 (Kvadrat)

Price group 4: Vidar, Moss (Kvadrat)

Net weight: 21.0 kg

Minimum order size: 1

Made to order

Dimensions (cm):

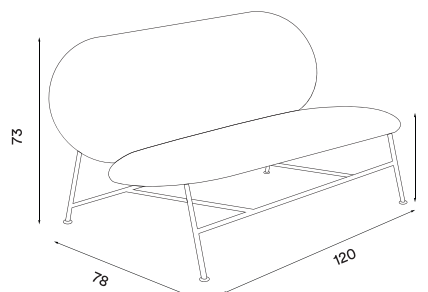

Prices NOK	(RRP ex. VAT)	(RRP incl. VAT)
Price group 0	14 392,-	17 990,-
Price group 1	18 392,-	22 990,-
Price group 2	19 192,-	23 990,-
Price group 3	19 992,-	24 990,-
Price group 4	20 792,-	25 990,-

Prices DKK	(RRP ex. VAT)	(RRP incl. VAT)
Price group 0	11 992,-	14 990,-
Price group 1	14 392,-	17 990,-
Price group 2	15 192,-	18 990,-
Price group 3	15 992,-	19 990,-
Price group 4	15 992,-	19 990,-

Prices SEK	(RRP ex. VAT)	(RRP incl. VAT)
Price group 0	15 992,-	19 990,-
Price group 1	19 992,-	24 990,-
Price group 2	20 792,-	25 990,-
Price group 3	21 592,-	26 990,-
Price group 4	23 192,-	28 990,-

Prices Euro	(RRP ex. VAT)	(RRP incl. VAT)
Price group 0	1 666,-	1 999,-
Price group 1	1 999,-	2 399,-
Price group 2	2 083,-	2 499,-
Price group 3	2 166,-	2 599,-
Price group 4	2 249,-	2 699,-



Pal stool

P. 46



Pal light oak mesh – *Item no. 2121*



Pal smoked oak mesh – *Item no. 2122*



Pal black oak mesh – *Item no. 2125*



Pal light oak – *Item no. 2123*



Pal smoked oak – *Item no. 2124*



Pal black oak – *Item no. 2126*

Product type: Stackable stool series

Design: Sami Kallio, 2018

Material legs: Solid oak

Material wood seat: Laminated oak veneer

Material mesh seat: Cane mesh

Colours: Light oiled oak, smoked oak finish or black painted oak

Net weight: 2.5 kg

Minimum order size: 1

Dimensions (cm) :

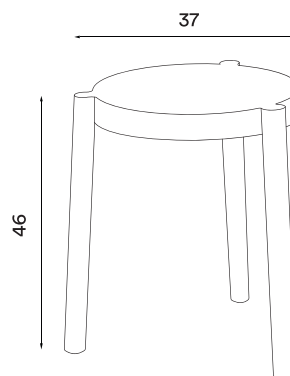

Prices NOK	(RRP ex. VAT)	(RRP incl. VAT)	Prices SEK	(RRP ex. VAT)	(RRP incl. VAT)
Wood seat	3 192,-	3 990,-	Wood seat	3 512,-	4 390,-
Mesh seat	3 592,-	4 490,-	Mesh seat	3 992,-	4 990,-
Prices DKK	(RRP ex. VAT)	(RRP incl. VAT)	Prices Euro	(RRP ex. VAT)	(RRP incl. VAT)
Wood seat	2 632,-	3 290,-	Wood seat	374,-	449,-
Mesh seat	2 872,-	3 590,-	Mesh seat	408,-	489,-



Pal bench

P. 47



Pal bench light oiled oak
– Item no. 2127



Pal bench smoked oak finish
– Item no. 2128



Pal bench black painted oak
– Item no. 2129

Product type: Bench
Design: Sami Kallio, 2020
Material legs: Solid oak
Material seat frame: Solid oak and laminated veneer
Material mesh seat: Cane mesh
Colours: Light oiled oak, smoked oak finish or black painted oak
Net weight: 4.0 kg
Minimum order size: 1

Dimensions (cm) :

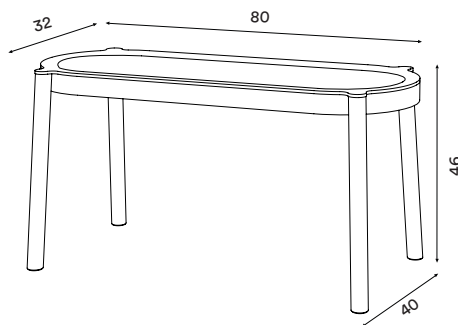

Prices NOK	(RRP ex. VAT)	(RRP incl. VAT)	Prices SEK	(RRP ex. VAT)	(RRP incl. VAT)
	6 392,-	7 990,-		7 112,-	8 890,-
Prices DKK	(RRP ex. VAT)	(RRP incl. VAT)	Prices Euro	(RRP ex. VAT)	(RRP incl. VAT)
	5 912,-	7 390,-		749,-	889,-



Plis sofa 2 seater

P. 48



Plis sofa 2 seater price group 0 – *Item no. 2700*
 Plis sofa 2 seater price group 1 – *Item no. 2701*
 Plis sofa 2 seater price group 2 – *Item no. 2702*

Plis sofa 2 seater price group 3 – *Item no. 2703*
 Plis sofa 2 seater price group 4 – *Item no. 2704*

Product type: Sofa

Design: Stine Aas, 2022

Material legs: Steel

Colour legs: Black (Ral 9005)

Materials seat and backrest: Plywood base, cold foam filling, textile cover

Price group 0: Cura (Gabriel)

Price group 1: Brusvik, Reflect (Kvadrat)

Price group 2: Remix 3, Atlas (Kvadrat)

Price group 3: Steelcut Trio 3, Fiord 2, Canvas 2 (Kvadrat)

Price group 4: Vidar, Moss (Kvadrat)

Net weight: 41.0 kg

Minimum order size: 1

Made to order

Dimensions (cm):

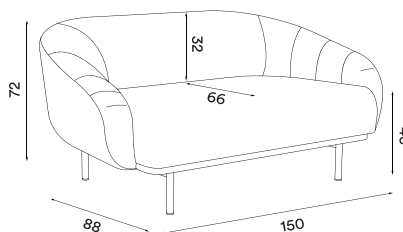

Prices NOK	(RRP ex. VAT)	(RRP incl. VAT)
Price group 0	23 992,-	29 990,-
Price group 1	29 592,-	36 990,-
Price group 2	31 920,-	39 900,-
Price group 3	34 392,-	42 990,-
Price group 4	36 792,-	45 990,-

Prices DKK	(RRP ex. VAT)	(RRP incl. VAT)
Price group 0	19 992,-	24 990,-
Price group 1	22 392,-	27 990,-
Price group 2	24 392,-	30 490,-
Price group 3	26 392,-	32 990,-
Price group 4	28 792,-	35 990,-

Prices SEK	(RRP ex. VAT)	(RRP incl. VAT)
Price group 0	26 392,-	32 990,-
Price group 1	31 992,-	39 990,-
Price group 2	35 192,-	43 990,-
Price group 3	37 592,-	46 990,-
Price group 4	39 992,-	49 990,-

Prices Euro	(RRP ex. VAT)	(RRP incl. VAT)
Price group 0	2 749,-	3 299,-
Price group 1	3 124,-	3 749,-
Price group 2	3 416,-	4 099,-
Price group 3	3 666,-	4 399,-
Price group 4	3 958,-	4 749,-



Plis sofa 3 seater

P. 49



Plis sofa 3 seater price group 0 – *Item no. 2710*

Plis sofa 3 seater price group 1 – *Item no. 2711*

Plis sofa 3 seater price group 2 – *Item no. 2712*

Plis sofa 3 seater price group 3 – *Item no. 2713*

Plis sofa 3 seater price group 4 – *Item no. 2714*

Product type: Sofa

Design: Stine Aas, 2022

Material legs: Steel

Colour legs: Black (Ral 9005)

Materials seat and backrest: Plywood base, cold foam filling, textile cover

Price group 0: Cura (Gabriel)

Price group 1: Brusvik, Reflect (Kvadrat)

Price group 2: Remix 3, Atlas (Kvadrat)

Price group 3: Steelcut Trio 3, Fiord 2, Canvas 2 (Kvadrat)

Price group 4: Vidar, Moss (Kvadrat)

Net weight: 58.0 kg

Minimum order size: 1

Made to order

Dimensions (cm):

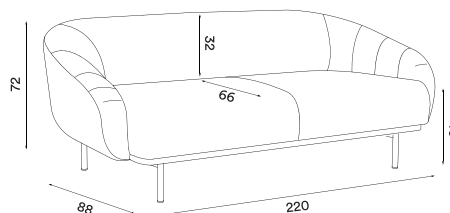

Prices NOK	(RRP ex. VAT)	(RRP incl. VAT)
Price group 0	27 992,-	34 990,-
Price group 1	35 192,-	43 990,-
Price group 2	38 392,-	47 990,-
Price group 3	43 192,-	53 990,-
Price group 4	46 392,-	57 990,-

Prices DKK	(RRP ex. VAT)	(RRP incl. VAT)
Price group 0	23 192,-	28 990,-
Price group 1	27 192,-	33 990,-
Price group 2	29 592,-	36 990,-
Price group 3	32 792,-	40 990,-
Price group 4	35 992,-	44 990,-

Prices SEK	(RRP ex. VAT)	(RRP incl. VAT)
Price group 0	31 192,-	38 990,-
Price group 1	38 392,-	47 990,-
Price group 2	42 392,-	52 990,-
Price group 3	47 192,-	58 990,-
Price group 4	51 192,-	63 990,-

Prices Euro	(RRP ex. VAT)	(RRP incl. VAT)
Price group 0	3 208,-	3 849,-
Price group 1	3 749,-	4 499,-
Price group 2	4 166,-	4 999,-
Price group 3	4 583,-	5 499,-
Price group 4	4 999,-	5 999,-





Shelter – Item no. 2221

Product type: Work desk

Design: Yonoh, 2018

Material table top: MDF, oak veneer

Colour table top: Smoked oak finish

Material body and legs: Steel

Material back screen: Perforated steel

Colour body, legs and back screen: Black

(Ral 9005)

Net weight: 33.5 kg

Minimum order size: 1

Dimensions (cm):

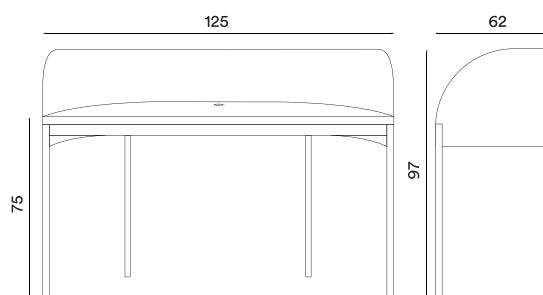

Prices NOK	(RRP ex. VAT)	(RRP incl. VAT)	Prices SEK	(RRP ex. VAT)	(RRP incl. VAT)
	15 192,-	18 990,-		16 792,-	20 990,-

Prices DKK	(RRP ex. VAT)	(RRP incl. VAT)	Prices Euro	(RRP ex. VAT)	(RRP incl. VAT)
	12 792,-	15 990,-		1 749,-	2 099,-



Stilk coffee table



Stilk top small black – *Item no. 2163*
Stilk legs high – *Item no. 2152*



Stilk top medium black – *Item no. 2173*
Stilk legs medium – *Item no. 2142*



Stilk top large black – *Item no. 2183*
Stilk legs low – *Item no. 2132*



Stilk top small sand – *Item no. 2162*
Stilk legs low – *Item no. 2132*



Stilk top medium sand – *Item no. 2172*
Stilk legs medium – *Item no. 2142*



Stilk top large sand – *Item no. 2182*
Stilk legs high – *Item no. 2152*

Product type: Coffee table series

Design: Morten & Jonas, 2018

Materials table top: MDF with laminate top

Colours table top: Black or sand

Material legs and table top frame: Steel

Colour legs and table top frame: Black (Ral 9005)

Net weight table tops: 2.4 kg / 3.7 kg / 9.4 kg

Net weight legs (3pcs): 0.66 kg / 0.80 kg / 0.96 kg

Minimum order size: 1

Dimensions (cm):

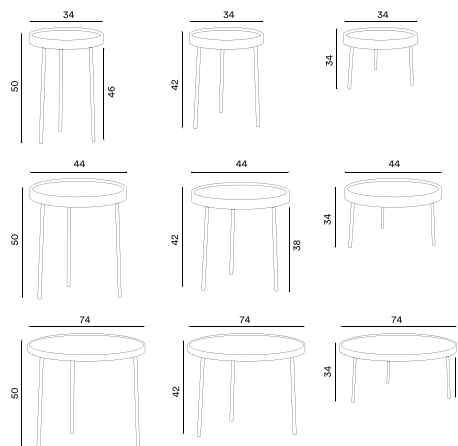

Prices NOK	(RRP ex. VAT)	(RRP incl. VAT)
Small top total	3 192,-	3 990,-
Medium top total	3 592,-	4 490,-
Large top total	5 592,-	6 990,-

Prices SEK	(RRP ex. VAT)	(RRP incl. VAT)
Small top total	3 512,-	4 390,-
Medium top total	3 912,-	4 890,-
Large top total	6 152,-	7 690,-

Prices DKK	(RRP ex. VAT)	(RRP incl. VAT)
Small top total	2 292,-	2 990,-
Medium top total	2 712,-	3 390,-
Large top total	4 312,-	5 390,-

Prices Euro	(RRP ex. VAT)	(RRP incl. VAT)
Small top total	333,-	399,-
Medium top total	383,-	459,-
Large top total	583,-	699,-





Ton side table

P. 53



Ton side table D40H50 – *Item no. 2460*



Ton side table D48H42 – *Item no. 2461*

Product type: Side table series
Design: Böttcher & Kayser, 2023
Material top and leg: Aluminium
Material base: Dark Emperor marble stone
Colours: Brushed aluminium and mixed brown marble
Net weight: 13.1 kg (D40), 14.1 kg (D48)
Minimum order size: 1

Dimensions (cm):

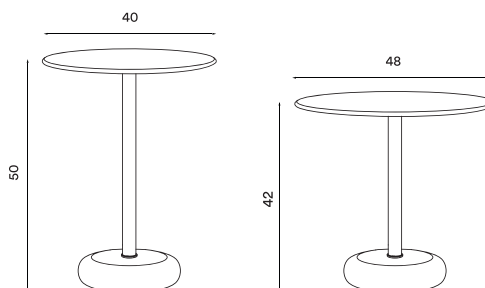

Prices NOK	(RRP ex. VAT)	(RRP incl. VAT)	Prices SEK	(RRP ex. VAT)	(RRP incl. VAT)
Ton D40H50	5 592,-	6 990,-	Ton D40H50	6 152,-	7 690,-
Ton D48H42	6 392,-	7 990,-	Ton D48H42	7 192,-	8 990,-

Prices DKK	(RRP ex. VAT)	(RRP incl. VAT)	Prices Euro	(RRP ex. VAT)	(RRP incl. VAT)
Ton D40H50	4 312,-	5 390,-	Ton D40H50	608,-	729,-
Ton D48H42	4 792,-	5 990,-	Ton D48H42	691,-	829,-



Treble bar stool

P. 54



Treble bar stool black
w/black painted oak seat
– Item no. 2440



Treble bar stool black
w/light oiled oak seat
– Item no. 2442



Treble bar stool white
w/light oiled oak seat
– Item no. 2444



Treble bar stool black w/black
painted oak and black leather seat
– Item no. 2441



Treble bar stool black w/light
oiled oak and brown leather seat
– Item no. 2443



Treble bar stool white w/light
oiled oak and brown leather seat
– Item no. 2445

Product type: Bar stool

Design: Mark Braun, 2021

Material legs: Steel

Colour legs: Black or white

Material seat: Solid oak

Colour seat: Black painted oak or light oiled oak

Material seat padding: Leather (Ultra from Sørensen)

Colour seat padding: Black (41599) (black version only)
or Camel (41571) (white version only)

Net weight: 5.1 kg

Minimum order size: 1

Dimensions (cm) :

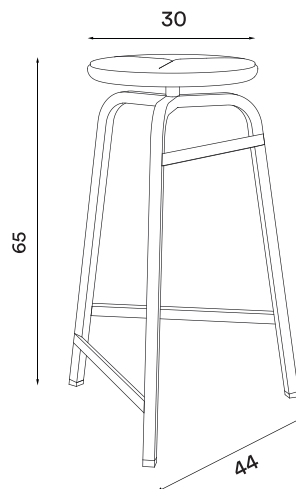

Prices NOK	(RRP ex. VAT)	(RRP incl. VAT)
Wood seat	3 192,-	3 990,-
Leather seat	4 552,-	5 690,-

Prices SEK	(RRP ex. VAT)	(RRP incl. VAT)
Wood seat	3 512,-	4 390,-
Leather seat	5 032,-	6 290,-

Prices DKK	(RRP ex. VAT)	(RRP incl. VAT)
Wood seat	2 392,-	2 990,-
Leather seat	3 512,-	4 390,-

Prices Euro	(RRP ex. VAT)	(RRP incl. VAT)
Wood seat	333,-	399,-
Leather seat	499,-	599,-



Valet wall console

P. 55



Valet wall console light oiled oak
- Item no. 2470



Valet wall console smoked oak finish
- Item no. 2471



Valet wall console black painted oak
- Item no. 2472

Product type: Wall console
Design: Sami Kallio, 2021
Material: MDF, oak veneer, solid oak
Colours: Light oiled oak, smoked oak finish or black painted oak
Material inside drawer: Leather (Ultra from Sørensen)
Colour inside drawer (leather): Camel (41571)
Net weight: 8.0 kg
Minimum order size: 1

Dimensions (cm) :

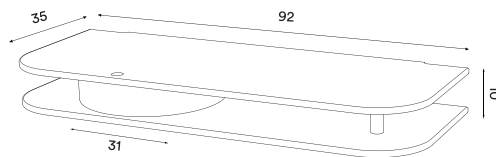

Prices NOK	(RRP ex. VAT)	(RRP incl. VAT)	Prices SEK	(RRP ex. VAT)	(RRP incl. VAT)
	7 752,-	9 690,-		8 792,-	10 990,-
Prices DKK	(RRP ex. VAT)	(RRP incl. VAT)	Prices Euro	(RRP ex. VAT)	(RRP incl. VAT)
	5 992,-	7 490,-		833,-	999,-



Valet wall drawer

P. 56



Valet wall drawer light oiled oak
- Item no. 2473



Valet wall drawer smoked oak finish
- Item no. 2474



Valet wall drawer black painted oak
- Item no. 2475

Product type: Wall drawer
Design: Sami Kallio, 2022
Material: MDF, oak veneer, solid oak
Colours: Light oiled oak, smoked oak finish or black painted oak
Material inside drawer: Leather (Ultra from Sørensen)
Colour inside drawer (leather): Camel (41571)
Net weight: 6.5 kg
Minimum order size: 1

Dimensions (cm) :

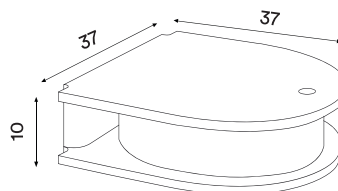

Prices NOK	(RRP ex. VAT)	(RRP incl. VAT)	Prices SEK	(RRP ex. VAT)	(RRP incl. VAT)
	5 592,-	6 990,-		6 152,-	7 690,-
Prices DKK	(RRP ex. VAT)	(RRP incl. VAT)	Prices Euro	(RRP ex. VAT)	(RRP incl. VAT)
	4 312,-	5 390,-		599,-	719,-



Yam lounge chair

P. 57



Yam lounge chair price group 0 – *Item no. 2010*

Yam lounge chair price group 1 – *Item no. 2011*

Yam lounge chair price group 2 – *Item no. 2012*

Yam lounge chair price group 3 – *Item no. 2013*

Yam lounge chair price group 4 – *Item no. 2019*

Product type: Pouf / Lounge chair series

Design: Mattias Stenberg, 2018

Material: Plywood base, moulded foam filling, textile cover

Price group 0: Cura (Gabriel)

Price group 1: Brusvik, Reflect (Kvadrat)

Price group 2: Remix 3, Atlas (Kvadrat)

Price group 3: Steelcut Trio 3, Fiord 2, Canvas 2 (Kvadrat)

Price group 4: Vidar, Moss (Kvadrat), Ultra leather (Sørensen Leather)

Net weight: 20.4 kg

Minimum order size: 1

Made to order

Dimensions (cm):

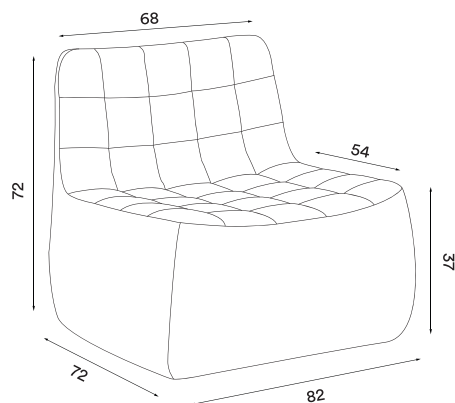

Prices NOK	(RRP ex. VAT)	(RRP incl. VAT)
Price group 0	13 592,-	16 990,-
Price group 1	15 992,-	19 990,-
Price group 2	17 592,-	21 990,-
Price group 3	19 992,-	24 990,-
Price group 4	21 592,-	26 990,-

Prices SEK	(RRP ex. VAT)	(RRP incl. VAT)
Price group 0	15 192,-	18 990,-
Price group 1	17 592,-	21 990,-
Price group 2	19 192,-	23 990,-
Price group 3	21 592,-	26 990,-
Price group 4	23 992,-	29 990,-

Prices DKK	(RRP ex. VAT)	(RRP incl. VAT)
Price group 0	11 192,-	13 990,-
Price group 1	12 792,-	15 990,-
Price group 2	13 592,-	16 990,-
Price group 3	15 592,-	19 490,-
Price group 4	16 792,-	20 990,-

Prices Euro	(RRP ex. VAT)	(RRP incl. VAT)
Price group 0	1 583,-	1 899,-
Price group 1	1 666,-	1 999,-
Price group 2	1 916,-	2 299,-
Price group 3	2 166,-	2 599,-
Price group 4	2 333,-	2 799,-



Yam pouf medium

P. 58



Yam medium price group 0 – *Item no. 2030*

Yam medium price group 1 – *Item no. 2031*

Yam medium price group 2 – *Item no. 2032*

Yam medium price group 3 – *Item no. 2033*

Yam medium price group 4 – *Item no. 2039*

Product type: Pouf / Lounge chair series

Design: Mattias Stenberg, 2018

Material: Plywood base, moulded foam filling, textile cover

Price group 0: Cura (Gabriel)

Price group 1: Brusvik, Reflect (Kvadrat)

Price group 2: Remix 3, Atlas (Kvadrat)

Price group 3: Steelcut Trio 3, Fiord 2, Canvas 2 (Kvadrat)

Price group 4: Vidar, Moss (Kvadrat), Ultra leather (Sørensen Leather)

Net weight: 11.5 kg

Minimum order size: 1

Made to order

Dimensions (cm):

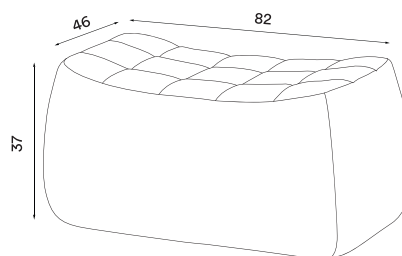

Prices NOK	(RRP ex. VAT)	(RRP incl. VAT)
Price group 0	7 992,-	9 990,-
Price group 1	10 392,-	12 990,-
Price group 2	11 992,-	14 990,-
Price group 3	12 792,-	15 990,-
Price group 4	14 392,-	17 990,-

Prices SEK	(RRP ex. VAT)	(RRP incl. VAT)
Price group 0	8 792,-	10 990,-
Price group 1	11 192,-	13 990,-
Price group 2	12 792,-	15 990,-
Price group 3	13 592,-	16 990,-
Price group 4	15 992,-	19 990,-

Prices DKK	(RRP ex. VAT)	(RRP incl. VAT)
Price group 0	6 552,-	8 190,-
Price group 1	7 992,-	9 990,-
Price group 2	9 592,-	11 990,-
Price group 3	10 392,-	12 990,-
Price group 4	11 192,-	13 990,-

Prices Euro	(RRP ex. VAT)	(RRP incl. VAT)
Price group 0	916,-	1 099,-
Price group 1	1 124,-	1 349,-
Price group 2	1 291,-	1 549,-
Price group 3	1 416,-	1 699,-
Price group 4	1 583,-	1 899,-





Yam pouf small price group 0 – *Item no. 2020*
 Yam pouf small price group 1 – *Item no. 2021*
 Yam pouf small price group 2 – *Item no. 2022*

Yam pouf small price group 3 – *Item no. 2023*
 Yam pouf small price group 4 – *Item no. 2040*

Product type: Pouf / Lounge chair series
Design: Mattias Stenberg, 2018
Material: Plywood base, moulded foam filling, textile cover
Price group 0: Cura (Gabriel)
Price group 1: Brusvik, Reflect (Kvadrat)
Price group 2: Remix 3, Atlas (Kvadrat)
Price group 3: Steelcut Trio 3, Fiord 2, Canvas 2 (Kvadrat)
Price group 4: Vidar, Moss (Kvadrat), Ultra leather (Sørensen Leather)
Net weight: 11 kg
Minimum order size: 1
Made to order

Dimensions (cm):

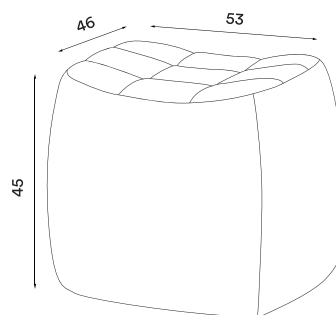

Prices NOK	(RRP ex. VAT)	(RRP incl. VAT)
Price group 0	6 392,-	7 990,-
Price group 1	9 592,-	11 990,-
Price group 2	10 392,-	12 990,-
Price group 3	11 192,-	13 990,-
Price group 4	11 992,-	14 990,-

Prices SEK	(RRP ex. VAT)	(RRP incl. VAT)
Price group 0	7 192,-	8 990,-
Price group 1	10 392,-	12 990,-
Price group 2	11 192,-	13 990,-
Price group 3	12 392,-	15 490,-
Price group 4	12 792,-	15 990,-

Prices DKK	(RRP ex. VAT)	(RRP incl. VAT)
Price group 0	5 192,-	6 490,-
Price group 1	7 432,-	9 290,-
Price group 2	7 992,-	9 990,-
Price group 3	8 792,-	10 990,-
Price group 4	9 592,-	11 900,-

Prices Euro	(RRP ex. VAT)	(RRP incl. VAT)
Price group 0	749,-	899,-
Price group 1	1 041,-	1 249,-
Price group 2	1 124,-	1 349,-
Price group 3	1 208,-	1 449,-
Price group 4	1 291,-	1 549,-



Accessories



Brim vase

P. 61



Brim vase H18
– Item no. 3150



Brim vase H28
– Item no. 3151

Product type: Vase

Design: Ann Kristin Einarsen, 2022

Material: Earthenware clay (ceramics),
glazed top and inside, coated outside

Colour: Beige

Net weight (H18): 0.8 kg

Net weight (H28): 2.0 kg

Minimum order size: 2

Dimensions (cm):

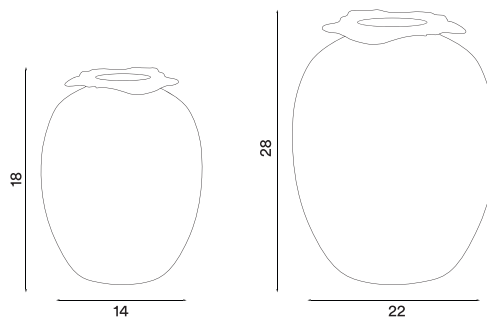

Prices NOK	(RRP ex. VAT)	(RRP incl. VAT)
H18	1 432,-	1 790,-
H28	1 592,-	1 990,-

Prices SEK	(RRP ex. VAT)	(RRP incl. VAT)
H18	1 592,-	1 990,-
H28	1 752,-	2 190,-

Prices DKK	(RRP ex. VAT)	(RRP incl. VAT)
H18	1 192,-	1 490,-
H28	1 272,-	1 590,-

Prices Euro	(RRP ex. VAT)	(RRP incl. VAT)
H18	166,-	199,-
H28	183,-	219,-



Cane broom set

P. 62



Cane black
- Item no. 3100

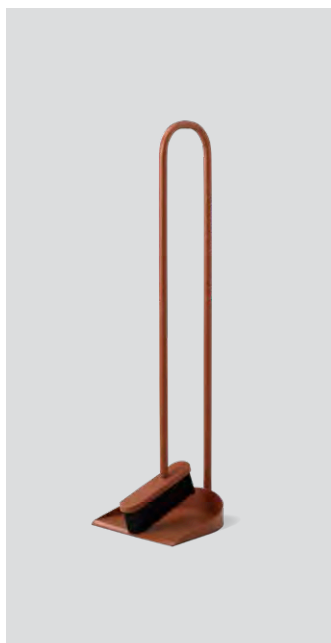

Cane rust
- Item no. 3101

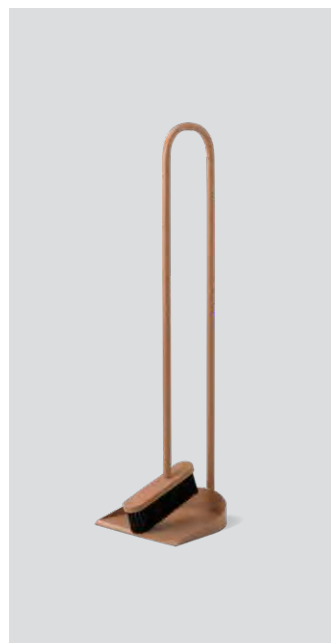

Cane warm beige
- Item no. 3102

Product type: Indoor broom with dustpan

Design: Gridy, 2019

Material: Steel

Colours: Black, rust or warm beige

Net weight: 1.9 kg

Minimum order size: 2

Spare parts available: Brush head

Dimensions (cm):

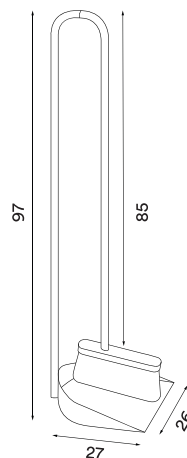

Prices NOK	(RRP ex. VAT) (RRP incl. VAT)		Prices SEK	(RRP ex. VAT) (RRP incl. VAT)	
		1 832,-		2 290,-	
Prices DKK	(RRP ex. VAT) (RRP incl. VAT)		Prices Euro	(RRP ex. VAT) (RRP incl. VAT)	
		1 432,-		1 790,-	



Dais stepstool

P. 63



Dais – Item no. 2241

Product type: Stepstool

Design: Gridy, 2018

Material body and steps: Steel

Colour: Black (Ral 9005)

Net weight: 11 kg

Minimum order size: 1

Dimensions (cm):

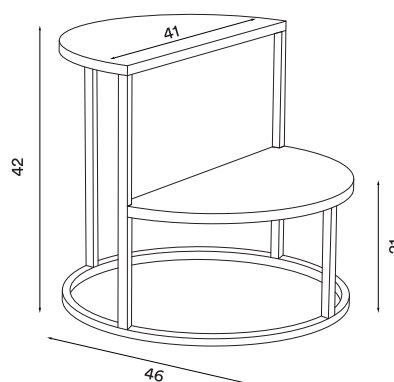

Prices NOK	(RRP ex. VAT)	(RRP incl. VAT)	Prices SEK	(RRP ex. VAT)	(RRP incl. VAT)
	3 592,-	4 490,-		3 919,-	4 899,-
Prices DKK	(RRP ex. VAT)	(RRP incl. VAT)	Prices Euro	(RRP ex. VAT)	(RRP incl. VAT)
	2 712,-	3 390,-		383,-	459,-



Echo cushion cover

P. 64



Echo cushion cover blue (vertical)
- Item no. 3270

Echo cushion cover yellow (horizontal)
- Item no. 3271

Echo cushion cover red (vertical)
- Item no. 3272

Product type: Cushion cover

Design: Mariken Steen-Forgaard, 2023

Material: Merino wool

Colours: Blue, yellow or red

Net weight: 0.2 kg

Minimum order size: 2

Dimensions (cm):

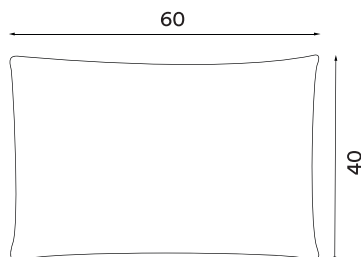

Prices NOK

(RRP ex. VAT) (RRP incl. VAT)

712,-	890,-
-------	-------

Prices SEK

(RRP ex. VAT) (RRP incl. VAT)

792,-	990,-
-------	-------

Prices DKK

(RRP ex. VAT) (RRP incl. VAT)

552,-	690,-
-------	-------

Prices Euro

(RRP ex. VAT) (RRP incl. VAT)

74,-	89,-
------	------







Echo throw blanket

P. 67



Echo throw blanket blue
- Item no. 3290



Echo throw blanket yellow
- Item no. 3291



Echo throw blanket red
- Item no. 3292

Product type: Throw blanket
Design: Mariken Steen-Forgaard, 2023
Material: New Zealand wool
Colours: Blue, yellow or red
Net weight: 1.1 kg
Minimum order size: 1

Dimensions (cm):

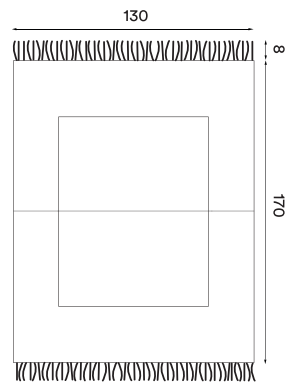

Prices NOK	(RRP ex. VAT) (RRP incl. VAT)		Prices SEK	(RRP ex. VAT) (RRP incl. VAT)	
		1 192,-		1 490,-	
Prices DKK	(RRP ex. VAT) (RRP incl. VAT)		Prices Euro	(RRP ex. VAT) (RRP incl. VAT)	
		872,-		1 090,-	



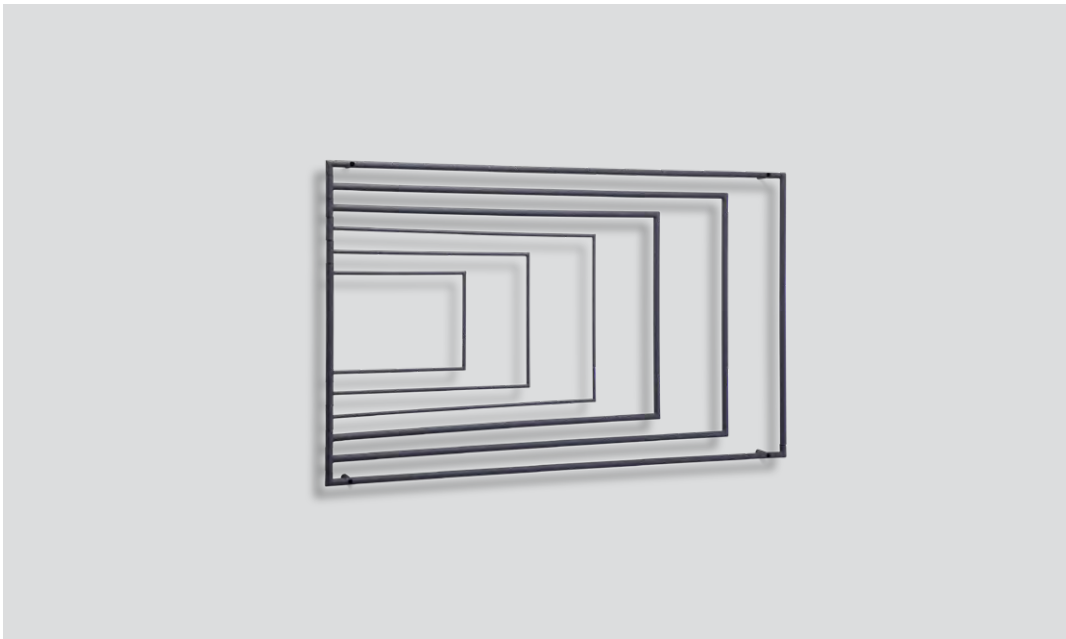

Frame
- Item no. 3041

Product type: Drying horse wall
Design: Cecilia Xinyu Zhang, 2018
Material: Steel
Colour: Black grey
Net weight: 5 kg
Minimum order size: 2

Dimensions (cm):

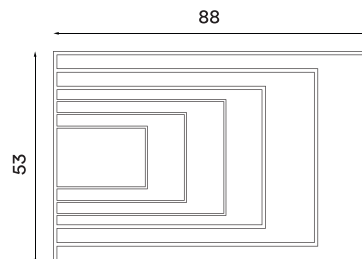

Prices NOK	(RRP ex. VAT)	(RRP incl. VAT)	Prices SEK	(RRP ex. VAT)	(RRP incl. VAT)
	3 112,-	3 890,-		3 432,-	4 290,-
Prices DKK	(RRP ex. VAT)	(RRP incl. VAT)	Prices Euro	(RRP ex. VAT)	(RRP incl. VAT)
	2 392,-	2 990,-		333,-	399,-

Grab watering can

P. 69



Grab plum
- Item no. 3081



Grab dark green
- Item no. 3082



Grab light yellow
- Item no. 3083

Product type: Watering can
Design: Stine Aas, 2019
Material: Stainless steel
Colours: Plum, dark green or light yellow
Container volume: 0.6 l
Net weight: 0.75 kg
Minimum order size: 4

Dimensions (cm):

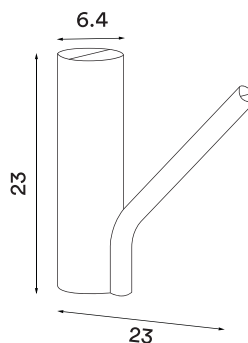

Prices NOK	(RRP ex. VAT) (RRP incl. VAT)		Prices SEK	(RRP ex. VAT) (RRP incl. VAT)	
		1 032,-		1 290,-	
Prices DKK	(RRP ex. VAT) (RRP incl. VAT)		Prices Euro	(RRP ex. VAT) (RRP incl. VAT)	
		792,-		990,-	



Granny candle holder

P. 70



Granny H11.5 black
- Item no. 806



Granny H11.5 white
- Item no. 808

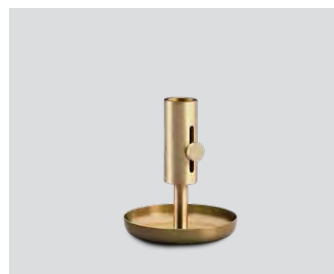

Granny H11.5 brass
- Item no. 805



Granny H16 black
- Item no. 807



Granny H16 white
- Item no. 809



Granny H16 brass
- Item no. 804

Product type: Candle holder series

Design: Rudi Wulff, 2015

Materials: Steel and brass (black and white versions), solid brass (brass version)

Colours: Black, white or brass

Net weight H11.5: 0.18 kg (black and white versions), 0.26 kg (brass version)

Net weight H16: 0.20 kg (black and white versions), 0.28 kg (brass version)

Minimum order size: 4

Dimensions (cm):

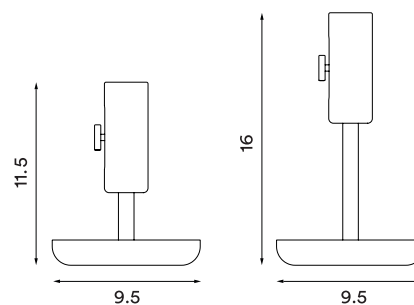

Prices NOK	(RRP ex. VAT)	(RRP incl. VAT)
H11.5 black/white	360,-	450,-
H16 black/white	392,-	490,-
H11.5 brass	552,-	690,-
H16 brass	632,-	790,-

Prices SEK	(RRP ex. VAT)	(RRP incl. VAT)
H11.5 black/white	392,-	490,-
H16 black/white	440,-	550,-
H11.5 brass	600,-	750,-
H16 brass	680,-	850,-

Prices DKK	(RRP ex. VAT)	(RRP incl. VAT)
H11.5 black/white	280,-	350,-
H16 black/white	312,-	390,-
H11.5 brass	440,-	550,-
H16 brass	520,-	650,-

Prices EUR	(RRP ex. VAT)	(RRP incl. VAT)
H11.5 black/white	41,-	49,-
H16 black/white	46,-	55,-
H11.5 brass	66,-	79,-
H16 brass	74,-	89,-



Granny candle holder

P. 71



Granny H32.5 black
- Item no. 3144



Granny H32.5 white
- Item no. 3142



Granny H32.5 brass
- Item no. 3140



Granny H44 black
- Item no. 3145



Granny H44 white
- Item no. 3143



Granny H44 brass
- Item no. 3141

Product type: Candle holder series

Design: Rudi Wulff, 2022

Materials: Steel and brass (black and white versions), solid brass (brass version)

Colours: Black, white or brass

Net weight H32.5: 0.5 kg (black and white versions), 0.6 kg (brass version)

Net weight H44: 0.5 kg (black and white versions), 0.6 kg (brass version)

Minimum order size: 2

Dimensions (cm):

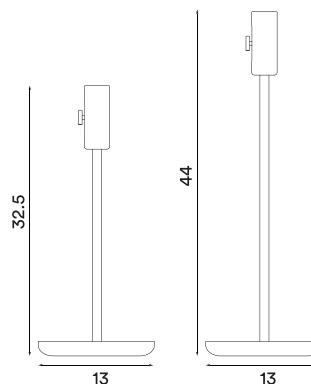

Prices NOK	(RRP ex. VAT)	(RRP incl. VAT)
H32.5 black/white	712,-	890,-
H44 black/white	792,-	990,-
H32.5 brass	1192,-	1490,-
H44 brass	1272,-	1590,-

Prices SEK	(RRP ex. VAT)	(RRP incl. VAT)
H32.5 black/white	792,-	990,-
H44 black/white	872,-	1090,-
H32.5 brass	1272,-	1590,-
H44 brass	1352,-	1690,-

Prices DKK	(RRP ex. VAT)	(RRP incl. VAT)
H32.5 black/white	552,-	690,-
H44 black/white	632,-	790,-
H32.5 brass	872,-	1090,-
H44 brass	952,-	1190,-

Prices EUR	(RRP ex. VAT)	(RRP incl. VAT)
H32.5 black/white	74,-	89,-
H44 black/white	83,-	99,-
H32.5 brass	124,-	149,-
H44 brass	133,-	159,-





Into vase

P. 73



Into dark blue - *Item no. 3160*



Into yellow - *Item no. 3161*



Into light grey - *Item no. 3162*



Into steel - *Item no. 3163*

Product type: Vase / tray
Design: Morten & Jonas, 2023
Material: Steel
Colours: Dark blue, yellow, light grey, steel (mirror finish)
Net weight: 1.6 kg
Minimum order size: 2

Dimensions (cm):

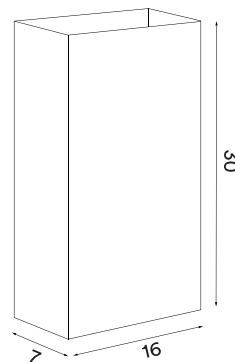

Prices NOK	(RRP ex. VAT)	(RRP incl. VAT)
	792,-	990,-

Prices SEK	(RRP ex. VAT)	(RRP incl. VAT)
	872,-	1 090,-

Prices DKK	(RRP ex. VAT)	(RRP incl. VAT)
	632,-	790,-

Prices Euro	(RRP ex. VAT)	(RRP incl. VAT)
	83,-	99,-



Mim outdoor broom

P. 74



Mim black/black
- *Item no. 3110*



Mim black/yellow
- *Item no. 3111*

Product type: Outdoor broom
Design: Vera & Kyte, 2019
Material body: Anodized aluminium
Colour body: Black
Colour brush and hanging loop: Black or light yellow
Net weight: 1.1 kg
Minimum order size: 2
Spare parts available: Brush head

Dimensions (cm):

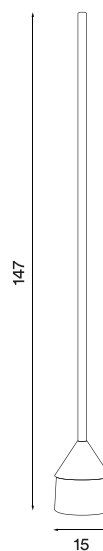

Prices NOK	(RRP ex. VAT)	(RRP incl. VAT)
	1 352,-	1 690,-

Prices SEK	(RRP ex. VAT)	(RRP incl. VAT)
	1 480,-	1 850,-

Prices DKK	(RRP ex. VAT)	(RRP incl. VAT)
	1 112,-	1 390,-

Prices Euro	(RRP ex. VAT)	(RRP incl. VAT)
	149,-	179,-



Monolith candle holder

P. 75



Low
white marble
- Item no. 3120



Medium
white marble
- Item no. 3121



Tall
white marble
- Item no. 3122



Wall
white marble
- Item no. 3123



Low
green marble
- Item no. 3124



Medium
green marble
- Item no. 3125



Tall
green marble
- Item no. 3126



Wall
green marble
- Item no. 3127



Low
steel
- Item no. 3128



Medium
steel
- Item no. 3129



Tall
steel
- Item no. 3130



Wall
steel
- Item no. 3131



Low
black
- Item no. 3132



Medium
black
- Item no. 3133



Tall
black
- Item no. 3134



Wall
black
- Item no. 3135

Product type: Candle holder series

Design: Morten & Jonas, 2022

Materials: White variegated Lilac marble stone (white marble version), Green Verde Prato marble stone (green marble version) or steel (steel and black version)

Colours: Mixed white marble, mixed green marble, steel or black

Net weight low: 0.7 kg (marble), 0.7 kg (steel)

Net weight medium: 1.2 kg (marble), 0.9 kg (steel)

Net weight large: 1.9 kg (marble), 1.4 kg (steel)

Net weight wall: 1.5 kg (marble), 0.7 kg (steel)

Minimum order size: 2

Dimensions (cm):

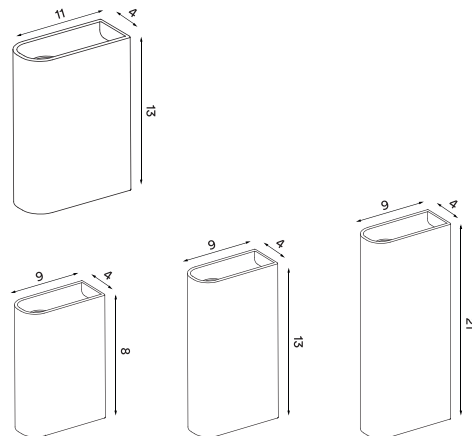

Prices NOK	(RRP ex. VAT)	(RRP incl. VAT)
Low	952,-	1190,-
Medium	1032,-	1290,-
Tall	1272,-	1590,-
Wall	1112,-	1390,-

Prices DKK	(RRP ex. VAT)	(RRP incl. VAT)
Low	712,-	890,-
Medium	792,-	990,-
Tall	1032,-	1290,-
Wall	872,-	1090,-

Prices SEK	(RRP ex. VAT)	(RRP incl. VAT)
Low	1032,-	1290,-
Medium	1112,-	1390,-
Tall	1352,-	1690,-
Wall	1192,-	1490,-

Prices EUR	(RRP ex. VAT)	(RRP incl. VAT)
Low	108,-	129,-
Medium	116,-	139,-
Tall	141,-	169,-
Wall	124,-	149,-



Nest wall hook

P. 76



Nest light yellow
- Item no. 3050



Nest pink
- Item no. 3051



Nest dark blue
- Item no. 3052



Nest dark green
- Item no. 3054



Nest warm beige
- Item no. 3056



Nest dark grey
- Item no. 3057



Nest black matt
- Item no. 3058



Nest white matt
- Item no. 3059



Nest aluminium
- Item no. 3060

Product type: Wall hook / storage

Design: Stine Aas, 2018

Materials hook: Aluminium

Materials cup: Steel or aluminium (aluminium version only)

Colours: Light yellow, pink, dark blue, dark green, warm beige, dark grey, black matt, white matt or brushed aluminium

Net weight: 0.33 kg

Minimum order size: 4

Dimensions (cm):

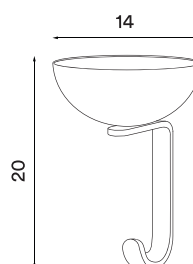

Prices NOK	(RRP ex. VAT)	(RRP incl. VAT)	Prices SEK	(RRP ex. VAT)	(RRP incl. VAT)
	472,-	590,-		520,-	650,-
Prices DKK	(RRP ex. VAT)	(RRP incl. VAT)	Prices Euro	(RRP ex. VAT)	(RRP incl. VAT)
	392,-	490,-		49,-	59,-



Nook ladder rack

P. 77

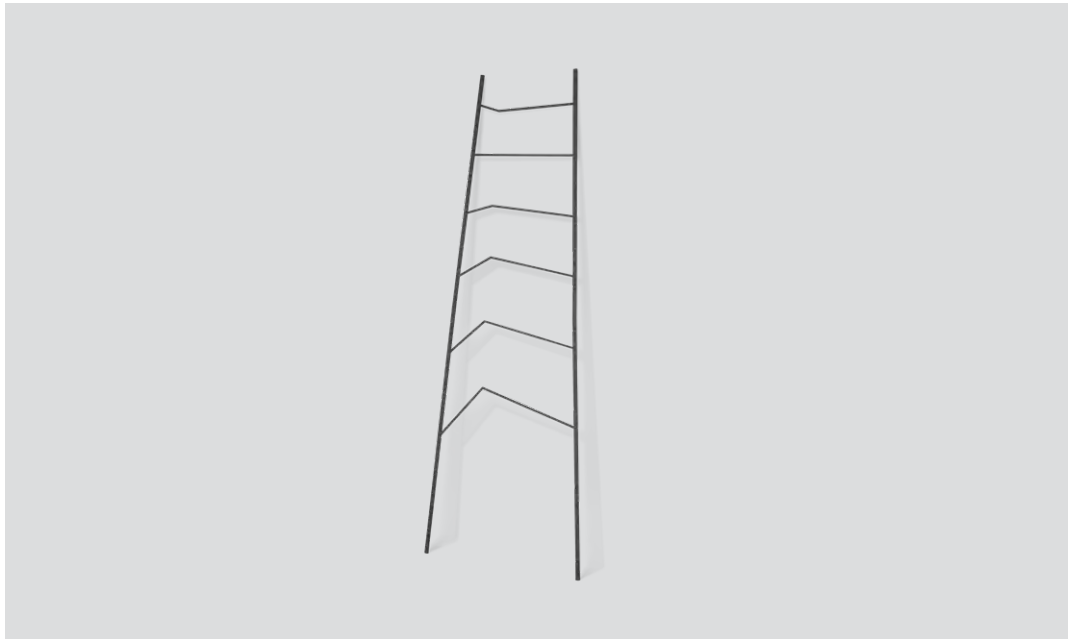

Nook
- Item no. 3042

Product type: Ladder rack
Design: Cecilia Xinyu Zhang, 2018
Material: Steel
Colour: Black grey
Net weight: 3.6 kg
Minimum order size: 2

Dimensions (cm):

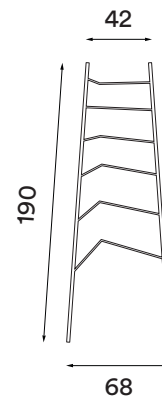

Prices NOK	(RRP ex. VAT)	(RRP incl. VAT)	Prices SEK	(RRP ex. VAT)	(RRP incl. VAT)
	2 312,-	2 890,-		2 552,-	3 190,-
Prices DKK	(RRP ex. VAT)	(RRP incl. VAT)	Prices Euro	(RRP ex. VAT)	(RRP incl. VAT)
	1 679,-	2 249,-		249,-	299,-



Oasis planter

P. 78



Product type: Planter series

Design: Ann Kristin Einarsen, 2018

Materials top part: Unglazed terracotta

Materials bottom part: Glazed or unglazed terracotta (dark brown/dark brown and terracotta/terracotta versions only)

Colours top part: Natural terracotta or brown terracotta (black/brown and dark brown/dark brown versions only)

Colours bottom part: Green, white, dark brown, black, natural terracotta or dark brown terracotta

Net weight small: 1.1 kg

Net weight medium: 1.9 kg

Net weight large: 3.6 kg

Minimum order size: 4 (small), 2 (medium and large)

Dimensions (cm):

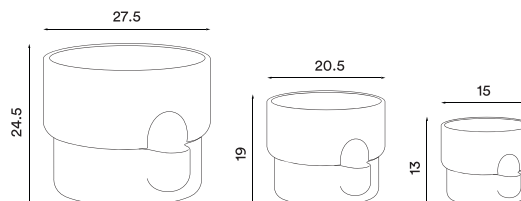

Prices NOK	(RRP ex. VAT)	(RRP incl. VAT)
Small	792,-	990,-
Medium	1 352,-	1 690,-
Large	1 912,-	2 390,-

Prices DKK	(RRP ex. VAT)	(RRP incl. VAT)
Small	632,-	790,-
Medium	1 032,-	1 290,-
Large	1 479,-	1 849,-

Prices SEK	(RRP ex. VAT)	(RRP incl. VAT)
Small	872,-	1 090,-
Medium	1 512,-	1 890,-
Large	2 119,-	2 649,-

Prices EUR	(RRP ex. VAT)	(RRP incl. VAT)
Small	83,-	99,-
Medium	146,-	175,-
Large	208,-	249,-



Observe tray

P. 79



Observe D32 smoked ash
- *Item no. 3034*



Observe D32 coral red
- *Item no. 3035*



Observe D32 dusty green
- *Item no. 3036*

Product type: Tray

Design: Ayla Gürsoy, 2022

Material: Solid ash

Colours: Smoked ash finish (oil),
coral red or dusty green (paint)

Net weight: 1.8 kg

Minimum order size: 2

Dimensions (cm):

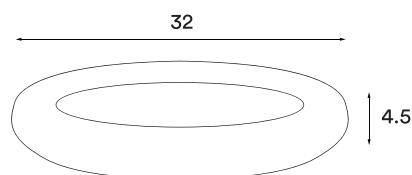

Prices NOK	(RRP ex. VAT)	(RRP incl. VAT)	Prices SEK	(RRP ex. VAT)	(RRP incl. VAT)
		1 832,-		2 290,-	
Prices DKK	(RRP ex. VAT)	(RRP incl. VAT)	Prices Euro	(RRP ex. VAT)	(RRP incl. VAT)
		1 432,-		1 790,-	





Peek circular small
- Item no. 3071



Peek oval small
- Item no. 3072



Peek circular large
- Item no. 3073



Peek oval large
- Item no. 3074

Product type: Wall mirror series

Design: Elina Ulvio, 2018

Materials: Steel, tinted mirror glass

Colour: Black

Net weight circular small: 2.2 kg

Net weight oval small: 4.1 kg

Net weight circular large: 8.6 kg

Net weight oval large: 11.0 kg

Minimum order size: 2 (small), 1 (large)

Dimensions (cm):

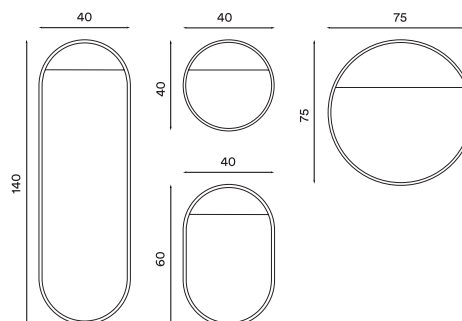

Prices NOK	(RRP ex. VAT)	(RRP incl. VAT)
Circular small	1 992,-	2 490,-
Oval small	2 392,-	2 990,-
Circular large	4 792,-	5 990,-
Oval large	5 592,-	6 990,-

Prices SEK	(RRP ex. VAT)	(RRP incl. VAT)
Circular small	2 152,-	2 690,-
Oval small	2 632,-	3 290,-
Circular large	5 272,-	6 590,-
Oval large	6 152,-	7 690,-

Prices DKK	(RRP ex. VAT)	(RRP incl. VAT)
Circular small	1 272,-	1 590,-
Oval small	1 992,-	2 490,-
Circular large	3 832,-	4 790,-
Oval large	4 472,-	5 590,-

Prices Euro	(RRP ex. VAT)	(RRP incl. VAT)
Circular small	183,-	219,-
Oval small	266,-	319,-
Circular large	541,-	649,-
Oval large	624,-	749,-

Podium board

P. 81



Podium L40 white marble
- Item no. 3002



Podium L65 white marble
- Item no. 3004



Podium L90 white marble
- Item no. 3006



Podium L40 black basalt stone
- Item no. 3003



Podium L65 black basalt stone
- Item no. 3005



Podium L90 black basalt stone
- Item no. 3007

Product type: Podium board series

Design: Jomi Evers, 2022

Materials: White Carrara marble stone (white version), or black basalt stone (black version)

Colours: White marble or black basalt

Net weight L40: 3.0 kg

Net weight L65: 4.5 kg

Net weight L90: 6.5 kg

Minimum order size: 2

Dimensions (cm):

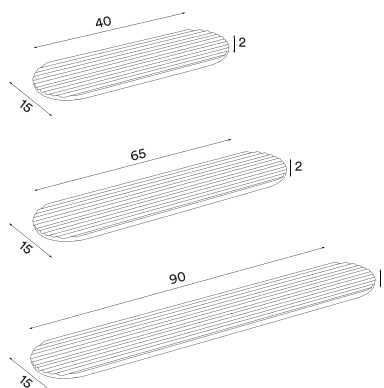

Prices NOK	(RRP ex. VAT)	(RRP incl. VAT)
L40	1432,-	1790,-
L65	1992,-	2490,-
L90	2392,-	2990,-

Prices SEK	(RRP ex. VAT)	(RRP incl. VAT)
L40	1592,-	1990,-
L65	2152,-	2690,-
L90	2632,-	3290,-

Prices DKK	(RRP ex. VAT)	(RRP incl. VAT)
L40	1192,-	1490,-
L65	1592,-	1990,-
L90	1912,-	2390,-

Prices EUR	(RRP ex. VAT)	(RRP incl. VAT)
L40	166,-	199,-
L65	224,-	269,-
L90	266,-	319,-



Row rugs

P. 82



Row rug medium light grey
– Item no. 3210



Row rug large light grey
– Item no. 3200



Row rug circular light grey
– Item no. 3220



Row rug circular large light grey – Item no. 3230

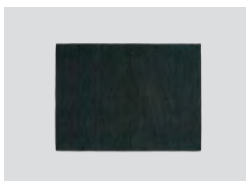

Row rug medium dark green
– Item no. 3211

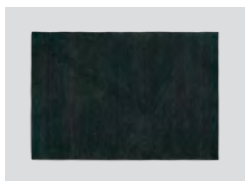

Row rug large dark green
– Item no. 3201

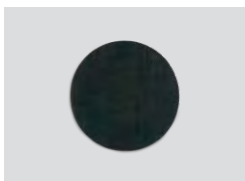

Row rug circular dark green
– Item no. 3221



Row rug circular large dark green – Item no. 3231



Row rug medium dark brown
– Item no. 3212

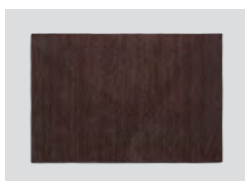

Row rug large dark brown
– Item no. 3202

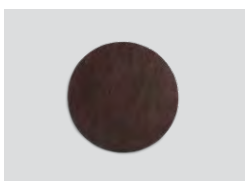

Row rug circular dark brown
– Item no. 3222



Row rug circular large dark brown – Item no. 3232

Product type: Rug series

Design: Studio Terhedebrügge, 2020

Material: New Zealand wool

Colours: Light grey, dark green or dark brown

Rug height: Ca. 16 mm

Net weight medium (170 x 140cm): 12.0 kg

Net weight large (200 x 300cm): 19.5 kg

Net weight circular (ø200cm): 10.5 kg

Net weight circular (ø270cm): 21.0 kg

Minimum order size: 1

Dimensions (cm):

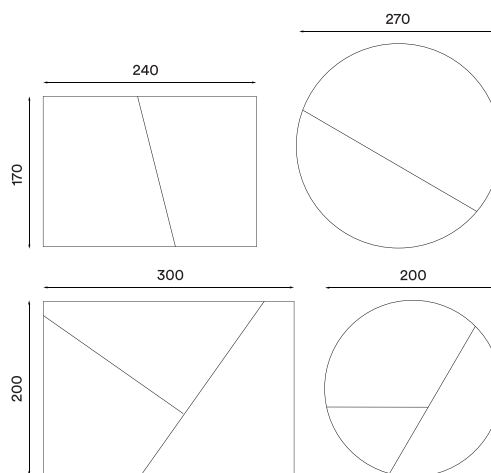

Prices NOK	(RRP ex. VAT)	(RRP incl. VAT)
Medium	11 192,-	13 990,-
Large	15 992,-	19 990,-
Circular	8 792,-	10 990,-
Circular large	18 392,-	22 990,-

Prices DKK	(RRP ex. VAT)	(RRP incl. VAT)
Medium	8 792,-	10 990,-
Large	12 792,-	15 990,-
Circular	6 792,-	8 490,-
Circular large	14 392,-	17 990,-

Prices SEK	(RRP ex. VAT)	(RRP incl. VAT)
Medium	12 392,-	15 490,-
Large	17 592,-	21 990,-
Circular	9 592,-	11 990,-
Circular large	19 992,-	24 990,-

Prices Euro	(RRP ex. VAT)	(RRP incl. VAT)
Medium	1 249,-	1 499,-
Large	1 833,-	2 199,-
Circular	916,-	1 099,-
Circular large	1 992,-	2 390,-



Spool rugs

P. 83



Spool runner 80 x 200 cm
grey and red – *Item no. 3250*



Spool runner 80 x 200 cm
grey and yellow – *Item no. 3251*



Spool runner 80 x 200 cm
grey and green – *Item no. 3252*



Spool rug 200 x 300 cm
grey and red – *Item no. 3240*



Spool rug 200 x 300 cm
grey and yellow – *Item no. 3241*



Spool rug 200 x 300 cm
grey and green – *Item no. 3242*

Product type: Indoor and outdoor rug series

Design: Studio Terhedebrügge, 2023

Material: 100% Recycled Polyester (rPET)

Colours: Grey and red, grey and yellow or grey and green

Rug height: Ca. 12 mm

Net weight runner (80 x 200 cm): 3.6 kg

Net weight rug (200 x 300 cm): 13.2 kg

Minimum order size: 1

Dimensions (cm):

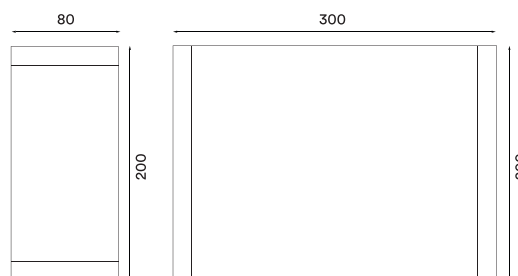

Prices NOK	(RRP ex. VAT)	(RRP incl. VAT)
Spool 80 x 200 cm	1 992,-	2 490,-
Spool 200 x 300 cm	7 992,-	9 990,-

Prices SEK	(RRP ex. VAT)	(RRP incl. VAT)
Spool 80 x 200 cm	2 152,-	2 690,-
Spool 200 x 300 cm	8 792,-	10 990,-

Prices DKK	(RRP ex. VAT)	(RRP incl. VAT)
Spool 80 x 200 cm	1 592,-	1 990,-
Spool 200 x 300 cm	6 152,-	7 690,-

Prices Euro	(RRP ex. VAT)	(RRP incl. VAT)
Spool 80 x 200 cm	216,-	259,-
Spool 200 x 300 cm	833,-	999,-





Trace flashlight

P. 85



Trace
- Item no. 3090

Product type: Flashlight
Design: Gridy, 2019
Material: Anodized aluminium and glass
Colour: Black
Light source: CREE LED 3 W, 4400 K.
Step dimmable, 100 / 240 / 360 lm.
Battery: USB rechargeable (Lithium Ion)
Battery duration: 4 - 15 hours
Charging cable: USB-C / USB-A
Charging time: 5 hours (fully charged)
Net weight: 0.35 kg (incl. battery)
Minimum order size: 4

Dimensions (cm):

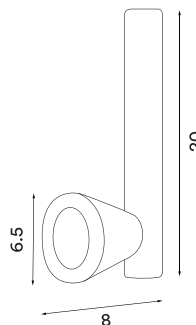

Prices NOK	(RRP ex. VAT)	(RRP incl. VAT)	Prices SEK	(RRP ex. VAT)	(RRP incl. VAT)
	1 352,-	1 690,-		1 480,-	1 850,-
Prices DKK	(RRP ex. VAT)	(RRP incl. VAT)	Prices Euro	(RRP ex. VAT)	(RRP incl. VAT)
	1 112,-	1 390,-		149,-	179,-





Lighting

Symbols



CE approval



Class 1

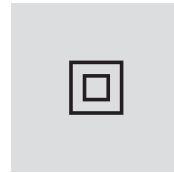

Class 2

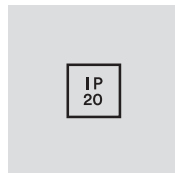

IP20

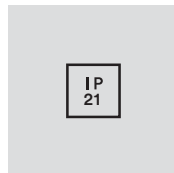

IP21

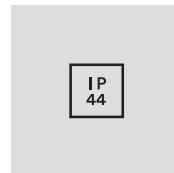

IP44

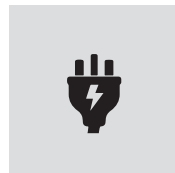

UK plug
available

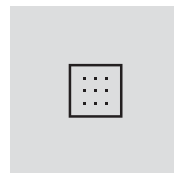

LED
(Light source)

Acorn floor

P. 88

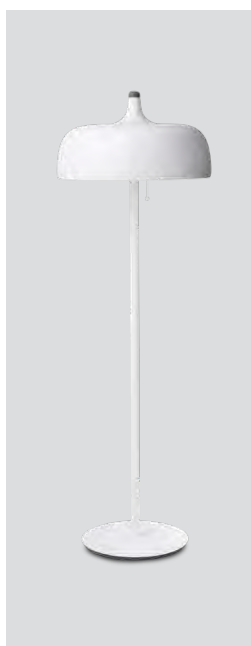

Acorn floor white matt
– Item no. 549



Acorn floor grey matt
– Item no. 550

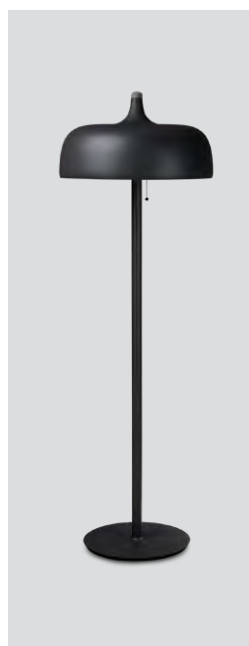

Acorn floor black matt
– Item no. 551



Light beech top



Dark walnut top

Product type: Floor lamp
Design: Atle Tveit, 2021
Shade material: Aluminium
Shade and body colour: White, grey or black
Shade inner colour: White
Body material: Steel
Wooden top part: Light beech or dark walnut (both colours are included)
Wire: White (white version), or black (grey and black versions), 200 cm
Switch: Pull string switch (on/off)
Bulb: E27, Max. 3 x 13 W LED only
Voltage: 220V - 240V - 50/60Hz
Net weight: 13.7 kg
Minimum order size: 1
Spare parts available: Wooden parts

Dimensions and light direction:

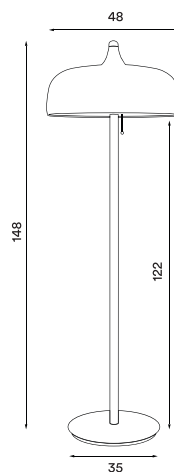

Recommended bulbs:

 LED – 11 W



Prices NOK (RRP ex. VAT) (RRP incl. VAT)

5 592,- 6 990,-

Prices SEK (RRP ex. VAT) (RRP incl. VAT)

6 152,- 7 690,-

Prices DKK (RRP ex. VAT) (RRP incl. VAT)

4 392,- 5 490,-

Prices Euro (RRP ex. VAT) (RRP incl. VAT)

608,- 729,-



Acorn pendant

P. 89

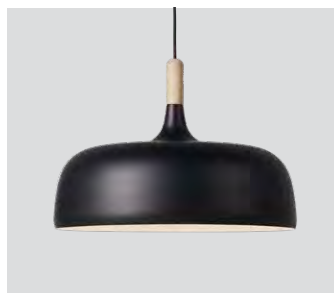

Acorn pendant white matt
– Item no. 543

Acorn pendant grey matt
– Item no. 544

Acorn pendant black matt
– Item no. 545

Product type: Pendant lamp

Design: Atle Tveit, 2012

Shade material: Aluminium

Shade colour: White, grey or black

Shade inner colour: White

Wooden parts: Light beech or dark walnut
(both colours are included)

Wire: White (white version), grey (grey version) or black (black version), silk 370 cm

Bulb: E27, Max. 100 W

Voltage: 220V - 240V - 50Hz

Net weight: 2.3 kg

Minimum order size: 1

Spare parts available: Ceiling mounted canopy, wooden parts

Dimensions and light direction:

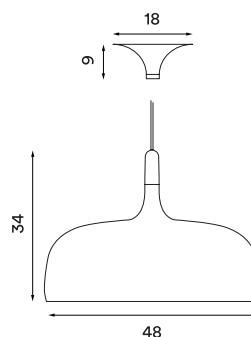

Recommended bulb:



Prices NOK

(RRP ex. VAT) (RRP incl. VAT)

3 192,-	3 990,-
---------	---------

Prices SEK

(RRP ex. VAT) (RRP incl. VAT)

3 512,-	4 390,-
---------	---------

Prices DKK

(RRP ex. VAT) (RRP incl. VAT)

2 632,-	3 290,-
---------	---------

Prices Euro

(RRP ex. VAT) (RRP incl. VAT)

374,-	449,-
-------	-------



Archive table

P. 90



Archive L25 black / steel – *Item no. 780*



Archive L25 dark green / light grey – *Item no. 781*



Archive L50 black / steel – *Item no. 782*



Archive L50 dark green / light grey – *Item no. 783*

Product type: Table lamp series

Design: Studio Sløyd, 2023

Shade material: Steel

Shade colour: Black (matt) or dark green (glossy)

Base material: Stainless steel (black/steel version only),

steel (light grey/dark green version only)

Base colour: Brushed steel or light grey (glossy)

Wire: Black rubber, 200 cm

Switch: 3-step touch dimmer (on lamp)

Bulb: Integrated LED, 9 W, 900 lm (L25 version),

11 W, 1100 lm (L50 version) 2700 K, CRI > 80, step dim

Voltage: 220V - 240V - 50/60Hz

Net weight: 1.9 Kg (L25 version), 3.5 Kg (L50 version)

Minimum order size: 2

Dimensions and light direction:

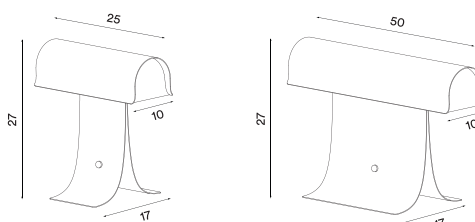

Light source included:

LED 9 W - Energy class: E

LED 11 W - Energy class: E



Prices NOK	(RRP ex. VAT)	(RRP incl. VAT)
Archive L25	2 792,-	3 490,-
Archive L50	3 992,-	4 990,-

Prices SEK	(RRP ex. VAT)	(RRP incl. VAT)
Archive L25	3 032,-	3 790,-
Archive L50	4 392,-	5 490,-

Prices DKK	(RRP ex. VAT)	(RRP incl. VAT)
Archive L25	2 152,-	2 690,-
Archive L50	3 192,-	3 990,-

Prices Euro	(RRP ex. VAT)	(RRP incl. VAT)
Archive L25	291,-	349,-
Archive L50	458,-	549,-







Balancer floor
– Item no. 665

Product type: Floor lamp
Design: Yuue, 2017
Base, body and shade material: Steel
Base, body and shade colour: Black matt
Light diffuser material: Mouth blown glass
Light diffuser colour: Opal white matt
Wire: Black, 200 cm
Dimmer switch: Black (on wire)
Bulb: E27, Max. 60 W (dimnable)
Voltage: 220V - 240V - 50Hz
Net weight: 16.0 kg
Minimum order size: 1
Spare parts available: Light diffuser glass

Dimensions and light direction:

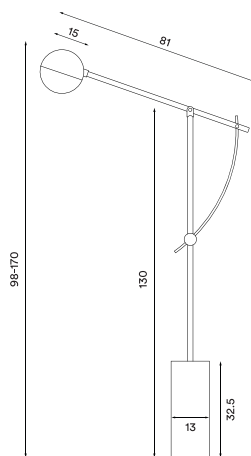

Recommended dimmable bulb:

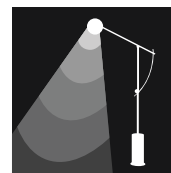

Prices NOK	(RRP ex. VAT)	(RRP incl. VAT)	Prices SEK	(RRP ex. VAT)	(RRP incl. VAT)
	7 992,-	9 990,-		8 792,-	10 990,-
Prices DKK	(RRP ex. VAT)	(RRP incl. VAT)	Prices Euro	(RRP ex. VAT)	(RRP incl. VAT)
	6 392,-	7 990,-		916,-	1 099,-

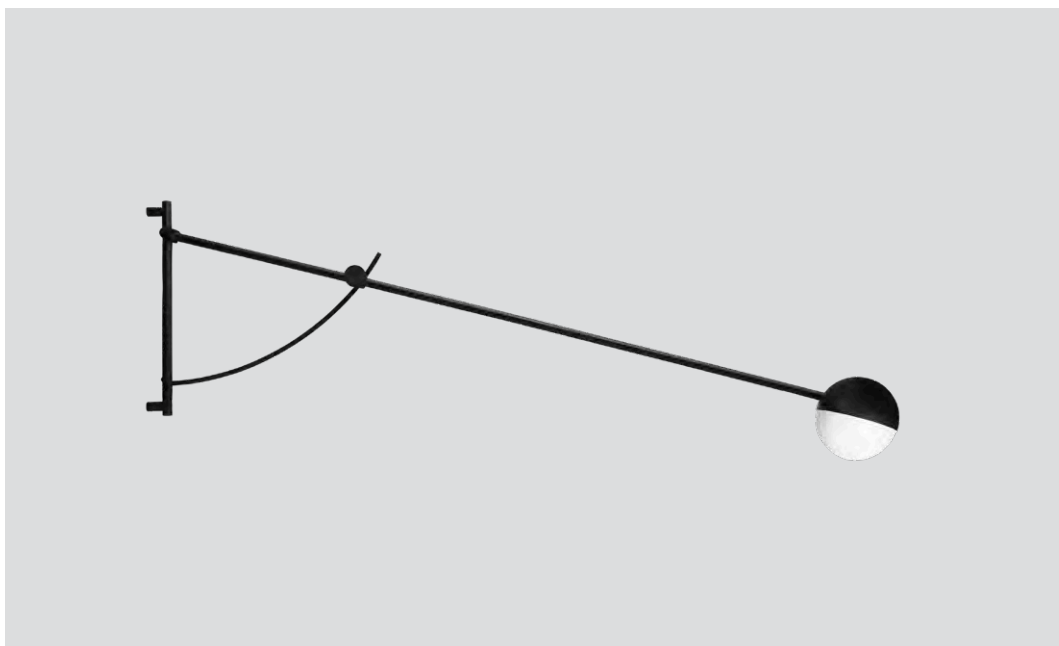

Balancer wall
– Item no. 670

Product type: Wall lamp

Design: Yuue, 2020

Base, body and shade material: Steel

Base, body and shade colour: Black matt

Light diffuser material: Mouth blown glass

Light diffuser colour: Opal white matt

Wire: Black, 200-260 cm (without switch)

Bulb: E27, Max. 60 W

Voltage: 220V - 240V - 50/60Hz

Net weight: 2.7 kg

Minimum order size: 1

Spare parts available: Light diffuser glass

Dimensions and light direction:

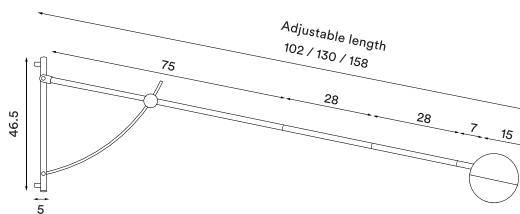

Recommended bulb:

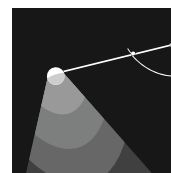

Prices NOK	(RRP ex. VAT)	(RRP incl. VAT)	Prices SEK	(RRP ex. VAT)	(RRP incl. VAT)
	6 392,-	7 990,-		7 192,-	8 990,-
Prices DKK	(RRP ex. VAT)	(RRP incl. VAT)	Prices Euro	(RRP ex. VAT)	(RRP incl. VAT)
	5 192,-	6 490,-		749,-	899,-

Balancer mini wall/table

P. 94



Balancer mini wall/table black
– Item no. 700

Balancer mini wall/table cherry red
– Item no. 702

Balancer mini wall/table steel
– Item no. 704

Product type: Wall and table lamp

Design: Yuue, 2022

Body and shade material: Steel

Body and shade colour: Black, cherry red or steel

Light diffuser material: Mouth blown glass

Light diffuser colour: Opal white matt

Wire: Black, 200 cm

Switch: 3-step touch dimmer (on lamp)

Bulb: Integrated LED 6 W, 550 lm, 2700/3000 K, CRI > 85, step dim

Voltage: 220V - 240V - 50/60Hz

Net weight: 1.0 kg

Minimum order size: 2

Dimensions and light direction:

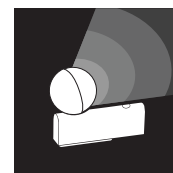
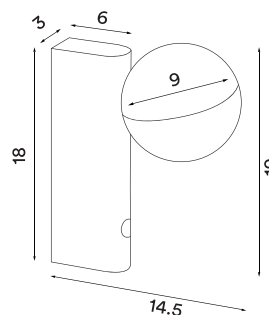

Light source included:

LED 6 W - Energy class: G/E

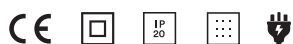

Prices NOK (RRP ex. VAT) (RRP incl. VAT)

2 392,-	2 990,-
---------	---------

Prices SEK (RRP ex. VAT) (RRP incl. VAT)

2 632,-	3 290,-
---------	---------

Prices DKK (RRP ex. VAT) (RRP incl. VAT)

1 912,-	2 390,-
---------	---------

Prices Euro (RRP ex. VAT) (RRP incl. VAT)

266,-	319,-
-------	-------



Birdy floor

P. 95



Birdy floor black / brass
– Item no. 620



Birdy floor white / steel
– Item no. 621



Birdy floor grey / steel
– Item no. 622



Birdy floor black / black
– Item no. 623



Birdy floor black / steel
– Item no. 624

Product type: Floor lamp
Design: Birger Dahl, 1952
Shade material: Aluminium
Shade, base and handle colours: White, grey or black (shade inner colour is same as outer colour)
Body material: Steel
Body and joints colour: Steel, brass or black
Wire: Black (grey and black versions only) or white (white version only), 200 cm (with on/off switch)
Bulb: E27, Max. 11 W LED only
Voltage: 220V - 240V - 50/60Hz
Net weight: 5.0 kg
Minimum order size: 1

Dimensions and light direction:

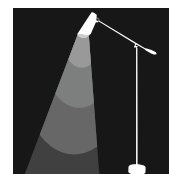
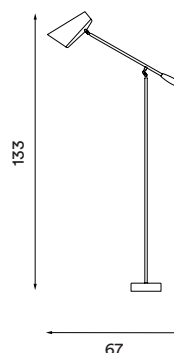

Recommended bulb:

 LED – 7 W



Prices NOK	(RRP ex. VAT) (RRP incl. VAT)		Prices SEK	(RRP ex. VAT) (RRP incl. VAT)	
		3 992,-		4 990,-	
Prices DKK	(RRP ex. VAT) (RRP incl. VAT)		Prices Euro	(RRP ex. VAT) (RRP incl. VAT)	
		3 192,-		3 990,-	



Birdy floor swing

P. 96

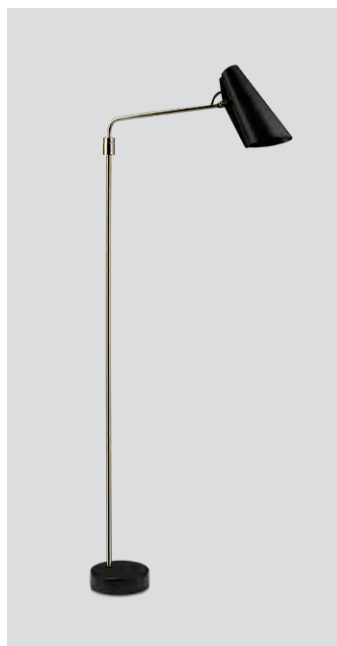

Birdy floor swing black / brass
– Item no. 628

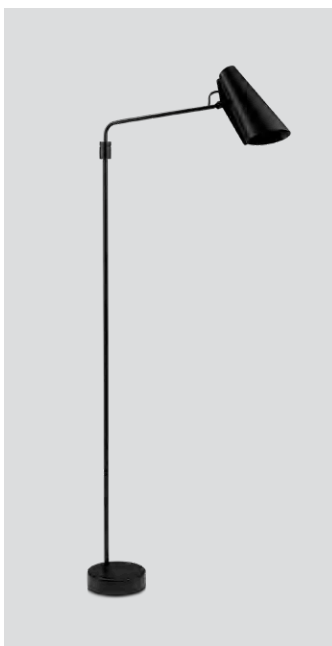

Birdy floor swing black / black
– Item no. 629

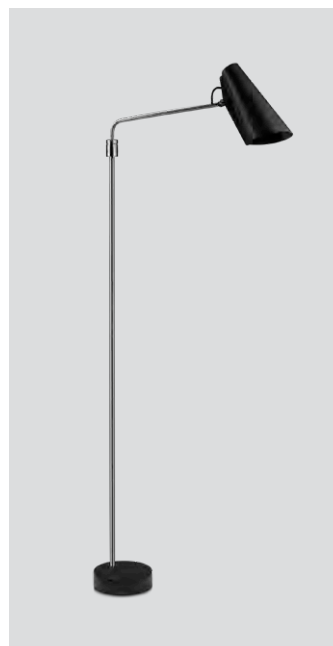

Birdy floor swing black / steel
– Item no. 609

Product type: Floor lamp
Design: Birger Dahl, 1952/2021
Shade material: Aluminium
Shade and base colours: Black (shade inner colour is same as outer colour)
Body material: Steel
Body and joints colour: Brass, black or steel
Wire: Black, 200 cm
Switch: On/off switch on the shade
Bulb: E27, Max. 11 W LED only
Voltage: 220V - 240V - 50/60Hz
Net weight: 5.3 kg
Minimum order size: 1

Dimensions and light direction:

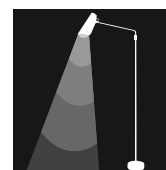
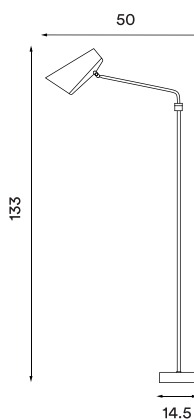

Recommended bulb:

 LED – 7 W



Prices NOK	(RRP ex. VAT)	(RRP incl. VAT)	Prices SEK	(RRP ex. VAT)	(RRP incl. VAT)
	3 992,-	4 990,-		4 392,-	5 490,-
Prices DKK	(RRP ex. VAT)	(RRP incl. VAT)	Prices Euro	(RRP ex. VAT)	(RRP incl. VAT)
	3 192,-	3 990,-		458,-	549,-



Birdy table

P. 97



Birdy table black/ brass
- Item no. 600



Birdy table white/ steel
- Item no. 601



Birdy table grey/ steel
- Item no. 602



Birdy table black/ black
- Item no. 604



Birdy table black/ steel
- Item no. 605

Product type: Table lamp

Design: Birger Dahl, 1952

Shade material: Aluminium

Shade, base and handle colours: White, grey or black (shade inner colour is same as outer colour)

Body material: Steel

Body and joints colour: Steel, brass or black

Wire: Black (grey and black versions only) or white (white version only), 200 cm (with switch)

Bulb: E27, Max. 11 W LED only

Voltage: 220V - 240V - 50/60Hz

Net weight: 1.9 kg

Minimum order size: 2

Dimensions and light direction:

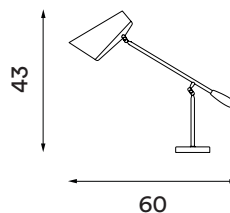

Recommended bulb:



Prices NOK	(RRP ex. VAT)	(RRP incl. VAT)	Prices SEK	(RRP ex. VAT)	(RRP incl. VAT)
	3 112,-	3 890,-		3 432,-	4 290,-
Prices DKK	(RRP ex. VAT)	(RRP incl. VAT)	Prices Euro	(RRP ex. VAT)	(RRP incl. VAT)
	2 392,-	2 990,-		333,-	399,-



Birdy table swing

P. 98



Birdy table swing black / brass
– Item no. 606



Birdy table swing black / black
– Item no. 607



Birdy table swing black / steel
– Item no. 608

Product type: Table lamp

Design: Birger Dahl, 1952/2021

Shade material: Aluminium

Shade and base colours: Black (shade inner colour is same as outer colour)

Body material: Steel

Body and joints colour: Brass, black or steel

Wire: Black, 200 cm

Switch: On/off switch on the shade

Bulb: E27, Max. 11 W LED only

Voltage: 220V - 240V - 50/60Hz

Net weight: 2.9 kg

Minimum order size: 2

Dimensions and light direction:

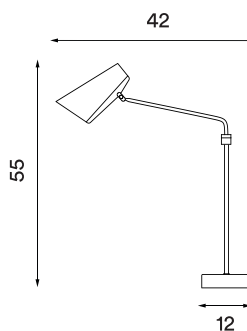

Recommended bulb:

LED – 7 W



Prices NOK

(RRP ex. VAT) (RRP incl. VAT)

3 112,-	3 890,-
---------	---------

Prices SEK

(RRP ex. VAT) (RRP incl. VAT)

3 432,-	4 290,-
---------	---------

Prices DKK

(RRP ex. VAT) (RRP incl. VAT)

2 392,-	2 990,-
---------	---------

Prices Euro

(RRP ex. VAT) (RRP incl. VAT)

333,-	399,-
-------	-------



Birdy wall

P. 99

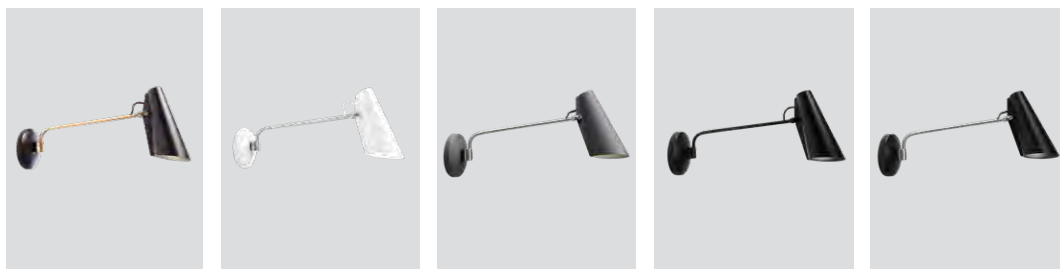

Birdy wall swing
black / brass
– Item no. 610

Birdy wall swing
white / steel
– Item no. 611

Birdy wall swing
grey / steel
– Item no. 612

Birdy wall swing
black / black
– Item no. 613

Birdy wall swing
black / steel
– Item no. 614

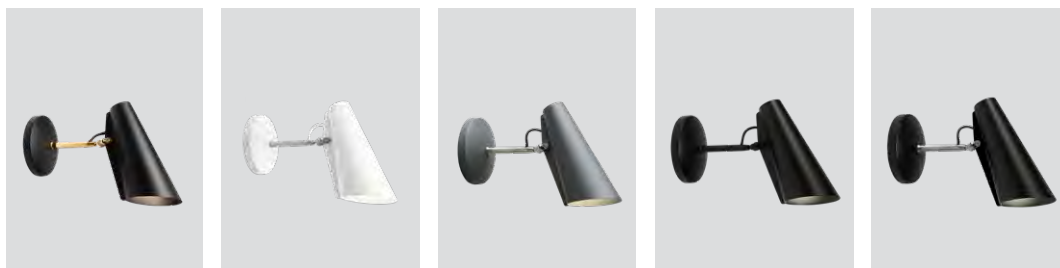

Birdy wall short
black / brass
– Item no. 615

Birdy wall short
white / steel
– Item no. 616

Birdy wall short
grey / steel
– Item no. 617

Birdy wall short
black / black
– Item no. 618

Birdy wall short
black / steel
– Item no. 619

Product type: Wall lamp

Design: Birger Dahl, 1952

Shade material: Aluminium

Shade and base colours: White, grey or black
(shade inner colour is same as outer colour)

Body material: Steel

Body and joints colour: Steel, brass or black

Wire: Black (grey or black versions only) or white
(white version only), 200 cm

Switch: On/off switch on the wire

Bulb: E27, Max. 11 W LED only

Voltage: 220V - 240V - 50/60Hz

Net weight: Birdy wall swing: 0.8 kg,

Birdy wall short: 0.7 kg

Minimum order size: 2

Dimensions and light direction:

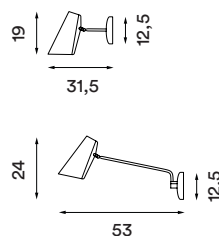

Recommended bulb:

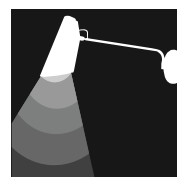

Prices NOK	(RRP ex. VAT)	(RRP incl. VAT)	Prices SEK	(RRP ex. VAT)	(RRP incl. VAT)
Long arm	2 792,-	3 490,-	Long arm	3 079,-	3 849,-
Short arm	2 392,-	2 990,-	Short arm	2 632,-	3 290,-
Prices DKK	(RRP ex. VAT)	(RRP incl. VAT)	Prices Euro	(RRP ex. VAT)	(RRP incl. VAT)
Long arm	2 152,-	2 690,-	Long arm	308,-	369,-
Short arm	1 992,-	2 490,-	Short arm	274,-	329,-



Blush pendant

P. 100

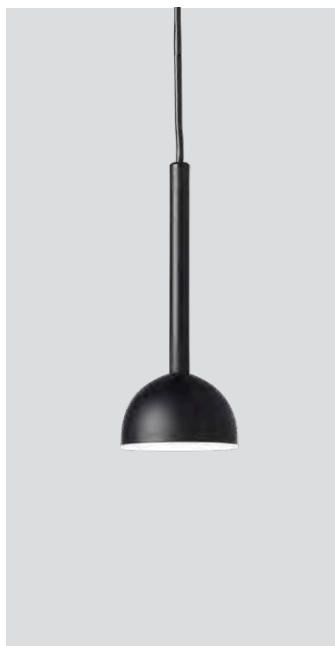

Blush pendant black matt
– Item no. 115



Blush pendant white matt
– Item no. 119

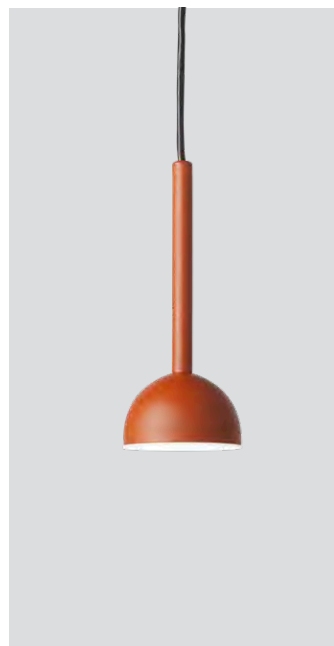

Blush pendant rust
– Item no. 118

Product type: Pendant lamp
Design: Morten & Jonas, 2019
Shade and body material: Steel
Shade and body colours: Black, white or rust
Light diffuser material: Opal acrylic
Wire: Black (black and rust version) or white (white version), 370 cm
Bulb: Integrated and dimmable LED 6 W, 550 lm, 2700/3000 K, CRI > 85
Voltage: 220V - 240V - 50/60Hz
Net weight: 0.70 kg
Minimum order size: 2
Spare parts available: LED module

Dimensions and light direction:

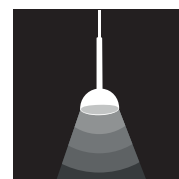
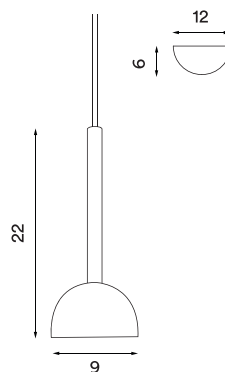

Light source included:

LED 6 W - Energy class: G/E



Prices NOK	(RRP ex. VAT)	(RRP incl. VAT)	Prices SEK	(RRP ex. VAT)	(RRP incl. VAT)
	1 912,-	2 390,-		2 119,-	2 649,-
Prices DKK	(RRP ex. VAT)	(RRP incl. VAT)	Prices EUR	(RRP ex. VAT)	(RRP incl. VAT)
	1 479,-	1 849,-		208,-	249,-



Blush pendant rail 3

P. 101

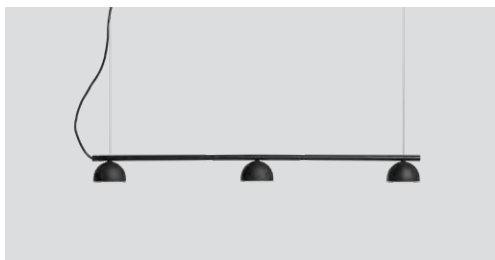

Blush pendant rail 3 black
- Item no. 150

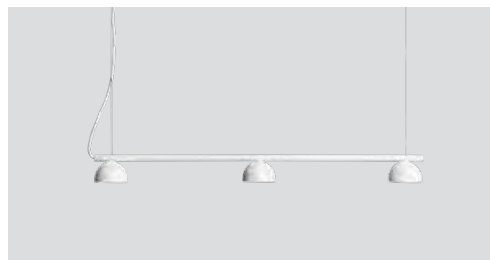

Blush pendant rail 3 white
- Item no. 152

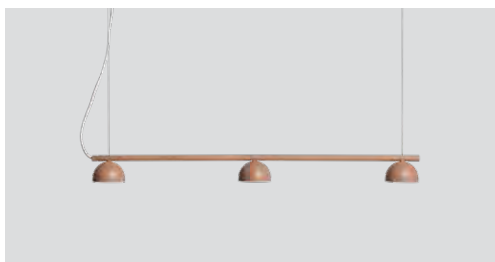

Blush pendant rail 3 warm beige
- Item no. 154

Product type: Pendant lamp
Design: Morten & Jonas, 2022
Shade and body material: Steel
Shade and body colours: Black, white or warm beige
Light diffuser material: Opal acrylic
Wire: Black (black version) or white (white and warm beige version), 370 cm
Steel hanging wire: 360 cm
Bulb: Integrated and dimmable LED 3 x 6 W, 1650 lm, 2700/3000 K, CRI > 85
Voltage: 220V - 240V - 50/60Hz
Net weight: 1.8 kg
Minimum order size: 2
Spare parts available: LED module

Dimensions and light direction:

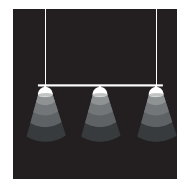
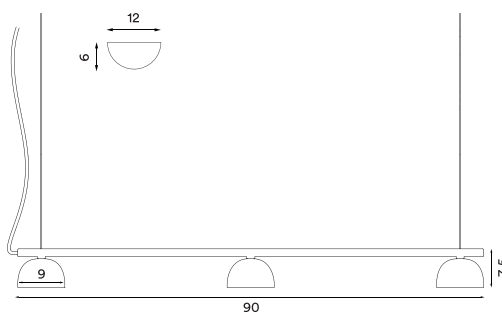

Light source included:

LED 3 x 6 W - Energy class: G/E



Prices NOK	(RRP ex. VAT)	(RRP incl. VAT)
	3 992,-	4 990,-

Prices SEK	(RRP ex. VAT)	(RRP incl. VAT)
	4 392,-	5 490,-

Prices DKK	(RRP ex. VAT)	(RRP incl. VAT)
	3 192,-	3 990,-

Prices EUR	(RRP ex. VAT)	(RRP incl. VAT)
	441,-	529,-



Blush pendant rail 5

P. 102

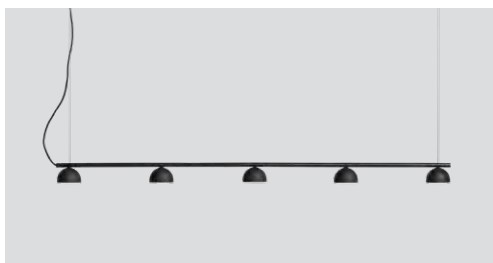

Blush pendant rail 5 black
- Item no. 151

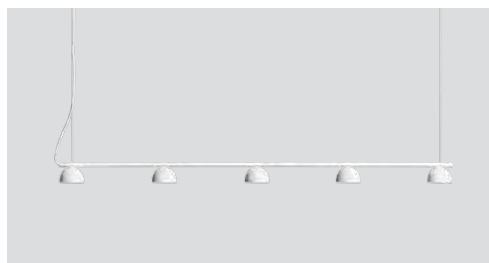

Blush pendant rail 5 white
- Item no. 153

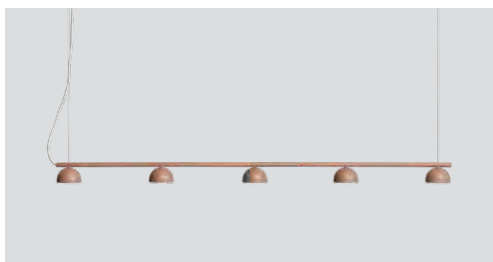

Blush pendant rail 5 warm beige
- Item no. 155

Product type: Pendant lamp
Design: Morten & Jonas, 2022
Shade and body material: Steel
Shade and body colours: Black, white or warm beige
Light diffuser material: Opal acrylic
Wire: Black (black version) or white (white and warm beige version), 370 cm
Steel hanging wire: 360 cm
Bulb: Integrated and dimmable LED 5 x 6 W, 3300 lm, 2700/3000 K, CRI > 85
Voltage: 220V - 240V - 50/60Hz
Net weight: 2.4 kg
Minimum order size: 2
Spare parts available: LED module

Dimensions and light direction:

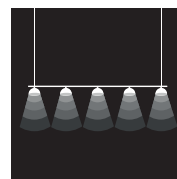
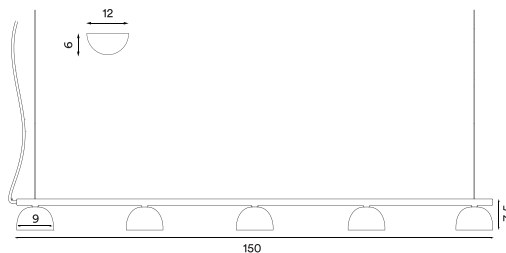

Light source included:

LED 5 x 6 W - Energy class: G/E



Prices NOK	(RRP ex. VAT)	(RRP incl. VAT)	Prices SEK	(RRP ex. VAT)	(RRP incl. VAT)
	5 592,-	6 990,-		6 152,-	7 690,-
Prices DKK	(RRP ex. VAT)	(RRP incl. VAT)	Prices EUR	(RRP ex. VAT)	(RRP incl. VAT)
	4 472,-	5 590,-		624,-	749,-





Blush wall black matt
– Item no. 113



Blush wall pink
– Item no. 111



Blush wall white matt
– Item no. 114

Product type: Wall lamp

Design: Morten & Jonas, 2018

Shade material: Steel

Body materials: Steel and silicone,
brass flexible arm

Shade and body colours: Black, pink or white

Light diffuser material: Opal acrylic

Wire: Black (black version only) or
white (pink or white versions), 200 cm

Switch: Dimmer switch on the wall base

Bulb: Integrated and dimmable LED 6 W,
550 lm, 2700/3000 K, CRI>85

Voltage: 220V - 240V - 50/60Hz

Net weight: 0.60 kg

Minimum order size: 2

Spare parts available: LED module

Dimensions and light direction:

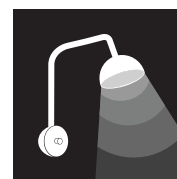
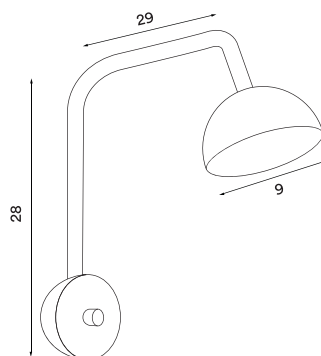

Light source included:

LED 6 W - Energy class: G/E



Prices NOK (RRP ex. VAT) (RRP incl. VAT)

2 392,- 2 990,-

Prices SEK (RRP ex. VAT) (RRP incl. VAT)

2 632,- 3 290,-

Prices DKK (RRP ex. VAT) (RRP incl. VAT)

1 832,- 2 290,-

Prices EUR (RRP ex. VAT) (RRP incl. VAT)

249,- 299,-

Buddy floor

P. 104



Buddy floor white
– Item no. 240

Buddy floor dark grey
– Item no. 241

Buddy floor dark green
– Item no. 242

Buddy floor warm beige
– Item no. 243

Buddy floor black
– Item no. 248

Product type: Floor lamp

Design: Mads Sætter-Lassen, 2019

Shade and body material: Steel

Colours: White, dark grey, dark green, warm beige or black (shade inner colour is same as outer colour)

Wire: Black or white (white version only), 200 cm

Switch: Dimmer switch on the floor base

Bulb: GU10, Max. 6 W LED only (dimmable)

Voltage: 220V - 240V - 50/60Hz

Net weight: 7.3 kg

Minimum order size: 1

Dimensions and light direction:

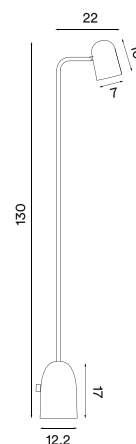

Recommended dimmable bulb:



Prices NOK

(RRP ex. VAT) (RRP incl. VAT)

3 752,-	4 690,-
---------	---------

Prices SEK

(RRP ex. VAT) (RRP incl. VAT)

4 152,-	5 190,-
---------	---------

Prices DKK

(RRP ex. VAT) (RRP incl. VAT)

2 872,-	3 590,-
---------	---------

Prices Euro

(RRP ex. VAT) (RRP incl. VAT)

408,-	489,-
-------	-------



Buddy table

P. 105



Buddy table white
- Item no. 230

Buddy table dark grey
- Item no. 233

Buddy table dark green
- Item no. 238

Buddy table warm beige
- Item no. 239

Buddy table black
- Item no. 249

Product type: Table lamp

Design: Mads Sætter-Lassen, 2016

Shade and body material: Steel

Colours: White, dark grey, dark green, warm beige or black (shade inner colour is same as outer colour)

Wire: Black or white (white version only), 200 cm

Switch: On/off switch on the wire

Bulb: GU10, Max. 6 W LED only

Voltage: 220V - 240V - 50Hz

Net weight: 2.1 kg

Minimum order size: 2

Dimensions and light direction:

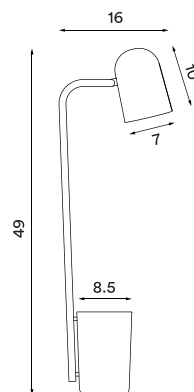

Recommended bulb:



Prices NOK

(RRP ex. VAT) (RRP incl. VAT)

2 392,-	2 990,-
---------	---------

Prices SEK

(RRP ex. VAT) (RRP incl. VAT)

2 632,-	3 290,-
---------	---------

Prices DKK

(RRP ex. VAT) (RRP incl. VAT)

1 832,-	2 290,-
---------	---------

Prices Euro

(RRP ex. VAT) (RRP incl. VAT)

249,-	299,-
-------	-------



Buddy wall

P. 106



Buddy wall white
– Item no. 220



Buddy wall dark grey
– Item no. 221



Buddy wall dark green
– Item no. 222



Buddy wall warm beige
– Item no. 223



Buddy wall black
– Item no. 224

Product type: Wall lamp

Design: Mads Sætter-Lassen, 2017

Shade and body material: Steel

Colours: White, dark grey, dark green, warm beige or black (shade inner colour is same as outer colour)

Wire: Black or white (white version only), 200 cm

Switch: Dimmer switch on the wall base

Bulb: GU10, Max. 6 W LED only (dimmable)

Voltage: 220V - 240V - 50/60Hz

Net weight: 0.4 kg

Minimum order size: 2

Dimensions and light direction:

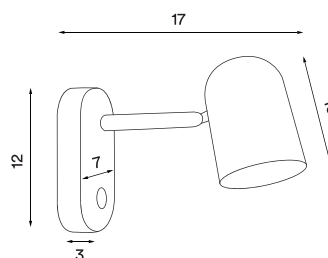

Recommended dimmable bulb:



Prices NOK	(RRP ex. VAT)	(RRP incl. VAT)	Prices SEK	(RRP ex. VAT)	(RRP incl. VAT)
	1 912,-	2 390,-		2 119,-	2 649,-
Prices DKK	(RRP ex. VAT)	(RRP incl. VAT)	Prices Euro	(RRP ex. VAT)	(RRP incl. VAT)
	1 479,-	1 849,-		208,-	249,-



Butterfly wall

P. 107



Butterfly white matt
– Item no. 330



Butterfly brass
– Item no. 322



Butterfly dark green
– Item no. 323



Butterfly black matt
– Item no. 321



Butterfly aluminium
– Item no. 329

Product type: Wall lamp

Design: Sven I. Dysthe, 1964

Shade material: Steel, brass or aluminium

Shade colour: White, black, dark green,
brushed brass or brushed aluminium

Body material: Steel

Body colour: White, black, brass, steel or dark green

Wire: White silk (white version), black silk (brass, black,
aluminium and dark green versions), 200 cm

Bulb: E27, Max. 60 W

Voltage: 220V - 240V - 50/60Hz

Net weight: 1,2 kg (white, black, brass and dark green
versions), 0,8 kg (aluminium version)

Minimum order size: 2

Spare part available: Wall bracket

Dimensions and light direction:

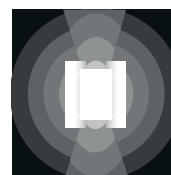
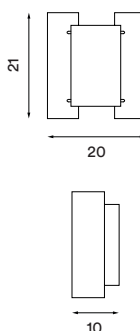

Recommended bulb:



Prices NOK	(RRP ex. VAT)	(RRP incl. VAT)
White, black, dark green	2 392,-	2 990,-
Aluminium	3 192,-	3 990,-
Brass	3 192,-	3 990,-

Prices DKK	(RRP ex. VAT)	(RRP incl. VAT)
White, black, dark green	1 992,-	2 490,-
Aluminium	2 632,-	3 290,-
Brass	2 632,-	3 290,-

Prices SEK	(RRP ex. VAT)	(RRP incl. VAT)
White, black, dark green	2 632,-	3 290,-
Aluminium	3 512,-	4 390,-
Brass	3 512,-	4 390,-

Prices Euro	(RRP ex. VAT)	(RRP incl. VAT)
White, black, dark green	266,-	319,-
Aluminium	333,-	399,-
Brass	374,-	449,-



Butterfly perforated wall

P. 108

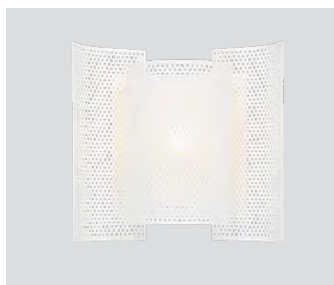

Butterfly perforated white matt
– Item no. 331

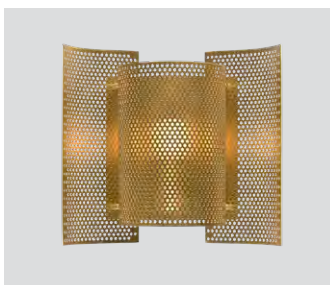

Butterfly perforated brass
– Item no. 325

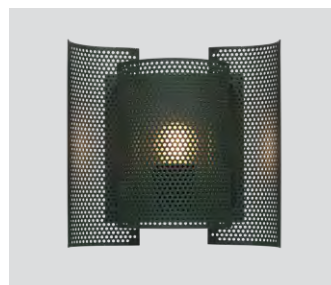

Butterfly perforated dark green
– Item no. 326



Butterfly perforated black matt
– Item no. 327

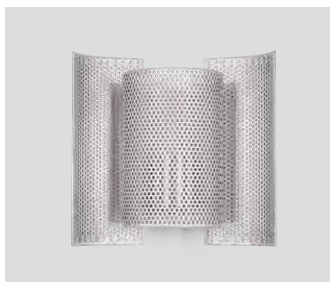

Butterfly perforated aluminium
– Item no. 328

Product type: Wall lamp

Design: Sven I. Dysthe, 1964

Shade material: Steel, brass or aluminium

Shade colour: White, black, dark green,
brushed brass or brushed aluminium

Body material: Steel

Body colour: White, black, dark green, brass or steel

Wire: White silk (white version), black silk (brass, black,
aluminium and dark green versions), 200 cm

Switch: Detachable pull string switch (on/off)

Bulb: E27, Max. 60 W

Voltage: 220V - 240V - 50/60Hz

Net weight: 1.2 kg (white, black, brass and dark green
versions), 0,8 kg (aluminium version)

Minimum order size: 2

Spare part available: Wall bracket

Dimensions and light direction:

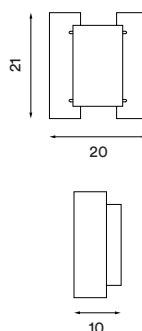

Recommended bulb:

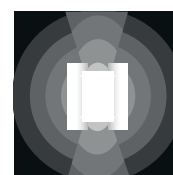

Prices NOK	(RRP ex. VAT)	(RRP incl. VAT)
White, black, dark green	2 392,-	2 990,-
Aluminium	3 192,-	3 990,-
Brass	3 192,-	3 990,-

Prices DKK	(RRP ex. VAT)	(RRP incl. VAT)
White, black, dark green	1 992,-	2 490,-
Aluminium	2 632,-	3 290,-
Brass	2 632,-	3 290,-

Prices SEK	(RRP ex. VAT)	(RRP incl. VAT)
White, black, dark green	2 632,-	3 290,-
Aluminium	3 512,-	4 390,-
Brass	3 512,-	4 390,-

Prices Euro	(RRP ex. VAT)	(RRP incl. VAT)
White, black, dark green	266,-	319,-
Aluminium	333,-	399,-
Brass	374,-	449,-



Circle pendant

P. 109

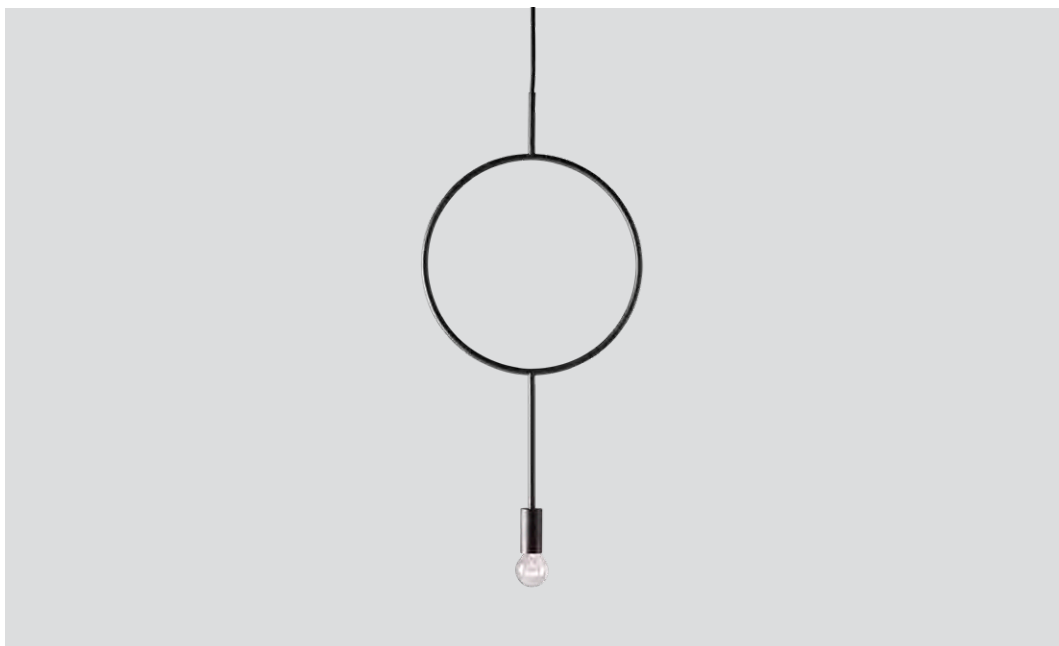

Circle

– Item no. 666

Product type: Pendant lamp
Design: Hannakaisa Pekkala, 2017
Body colour: Dark grey
Body material: Steel
Wire: Black rubber, 370 cm
Bulb: E14, Max. 40 W
Voltage: 220V - 240V - 50Hz
Net weight: 0.6 kg
Minimum order size: 2

Dimensions and light direction:

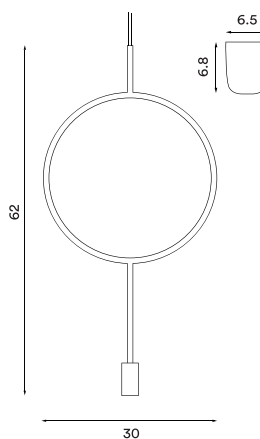

Recommended bulb:

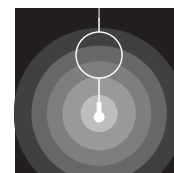

Prices NOK	(RRP ex. VAT)	(RRP incl. VAT)	Prices SEK	(RRP ex. VAT)	(RRP incl. VAT)
	1 592,-	1 990,-		1 752,-	2 190,-
Prices DKK	(RRP ex. VAT)	(RRP incl. VAT)	Prices Euro	(RRP ex. VAT)	(RRP incl. VAT)
	1 272,-	1 590,-		183,-	219,-



Dahl pendant

P. 110



Dahl small hanging part brass matt – *Item no. 491*

Dahl small glass shade – *Item no. 495*



Dahl small hanging part dark grey – *Item no. 492*

Dahl small glass shade – *Item no. 495*



Dahl large hanging part brass matt – *Item no. 445*

Dahl large glass shade – *Item no. 444*



Dahl large hanging part dark grey – *Item no. 446*

Dahl large glass shade – *Item no. 444*

Product type: Pendant lamp series

Design: Birger Dahl, 1956

Shade material: Glass

Shade colour: Opal white matt

Body material: Steel

Body colours: Brass matt or dark grey

Wire: Black rubber, 370 cm

Bulb: E27, Max. 40 W (small),

E27, Max. 100 W (large)

Voltage: 220V - 240V - 50Hz

Net weight: 0.8 Kg (small), 2.1 Kg (large)

Minimum order size: 2

Spare parts available: Light diffuser ring, cord grip canopy, glass shade

Dimensions and light direction:

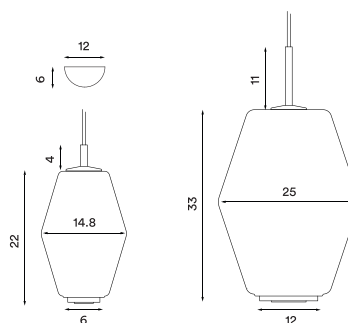

Recommended bulbs:

LED – 7 W

LED – 9 W

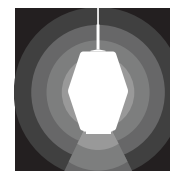

Prices NOK	(RRP ex. VAT)	(RRP incl. VAT)
Dahl small	2 632,-	3 290,-
Dahl large	3 192,-	3 990,-

Prices SEK	(RRP ex. VAT)	(RRP incl. VAT)
Dahl small	2 792,-	3 490,-
Dahl large	3 512,-	4 390,-

Prices DKK	(RRP ex. VAT)	(RRP incl. VAT)
Dahl small	1 912,-	2 390,-
Dahl large	2 392,-	2 990,-

Prices Euro	(RRP ex. VAT)	(RRP incl. VAT)
Dahl small	283,-	339,-
Dahl large	332,-	399,-



Diva pendant / floor

P. 111



Diva floor oak
– Item no. 370



Diva floor smoked oak
– Item no. 372



Diva pendant oak
– Item no. 380



Diva pendant smoked oak
– Item no. 382

Diva floor base – Item no. 390

Diva hanging part – Item no. 391

Product type: Floor lamp and pendant lamp series
Design: Peter Natedal & Thomas Kalvatn Egset, 2009
Shade material and colour: Oak or smoked oak, laminated plywood
Glass shade material: Mouth blown glass
Glass shade colour: Opal white matt
Body material and colour: Steel
Wire: Transparent, 200 cm (floor) and 370 cm (pendant)
Dimmer switch: Transparent (floor lamp only)
Bulb: G9, Max. 6 W LED only (dimmable)
Voltage: 220V - 240V - 50/60Hz
Net weight: 7 kg (floor lamp), 4.5 kg (pendant lamp)
Minimum order size: 1
Spare parts available: Glass shade

Dimensions and light direction:

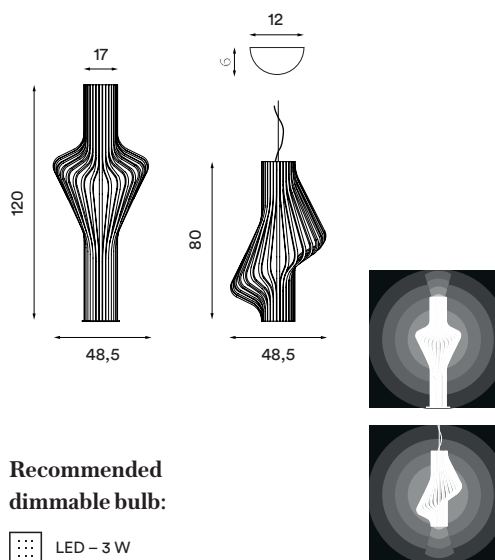

Recommended dimmable bulb:

LED – 3 W



Prices NOK	(RRP ex. VAT)	(RRP incl. VAT)
	25 592,-	31 990,-

Prices SEK	(RRP ex. VAT)	(RRP incl. VAT)
	27 992,-	34 990,-

Prices DKK	(RRP ex. VAT)	(RRP incl. VAT)
	19 592,-	24 490,-

Prices Euro	(RRP ex. VAT)	(RRP incl. VAT)
	2 749,-	3 299,-



Dokka pendant

P. 112



Dokka dark green
– Item no. 251



Dokka light yellow
– Item no. 252



Dokka rust
– Item no. 253

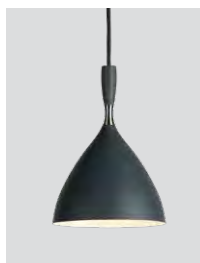

Dokka dark grey
– Item no. 256



Dokka white matt
– Item no. 274



Dokka black matt
– Item no. 275



Dokka warm beige
– Item no. 276



Dokka steel
– Item no. 277

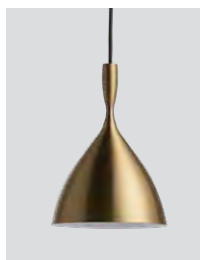

Dokka brass
– Item no. 278

Product type: Pendant lamp

Design: Birger Dahl, 1954

Shade material: Steel or brass (brass version only)

Shade ring material: Brass

Shade colours: Dark green, light yellow, rust, dark grey, white matt, black matt, warm beige, brushed steel or brushed brass

Shade inner colour: White

Wire: White rubber (white version only) or black rubber (all other versions), 370 cm

Bulb: E27, Max. 60 W

Voltage: 220V - 240V - 50/60Hz

Net weight: 0.9 kg

Minimum order size: 2

Spare part available: Cord grip canopy

Dimensions and light direction:

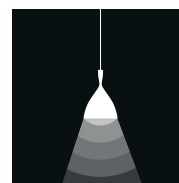
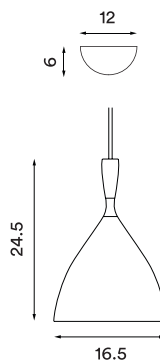

Recommended bulb:



Prices NOK (RRP ex. VAT) (RRP incl. VAT)

Steel versions	2 232,-	2 790,-
Brass	2 712,-	3 390,-

Prices DKK (RRP ex. VAT) (RRP incl. VAT)

Steel versions	1 752,-	2 190,-
Brass	2 072,-	2 590,-

Prices SEK (RRP ex. VAT) (RRP incl. VAT)

Steel versions	2 472,-	3 090,-
Brass	2 952,-	3 690,-

Prices Euro (RRP ex. VAT) (RRP incl. VAT)

Steel versions	241,-	289,-
Brass	291,-	349,-





Gear floor
– Item no. 410

Product type: Floor lamp
Design: Johan Lindstén, 2018
Base, body and shade material: Steel
Base, body and shade colour: Black
Shade inner colour: White
Wire (with dimmer switch): Black, 200 cm
Bulb: E27, Max. 100 W (dimmable)
Voltage: 220V - 240V - 50/60Hz
Net weight: 17.1 kg
Minimum order size: 1

Dimensions and light direction:

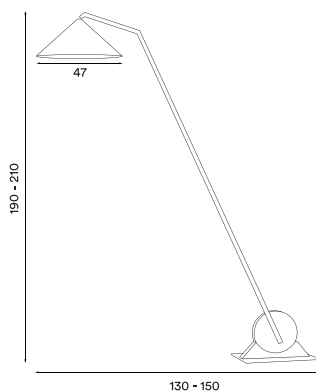

Recommended dimmable bulb:

LED – 11 W

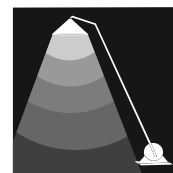

Prices NOK	(RRP ex. VAT)	(RRP incl. VAT)
	17 192,-	21 490,-

Prices SEK	(RRP ex. VAT)	(RRP incl. VAT)
	19 192,-	23 990,-

Prices DKK	(RRP ex. VAT)	(RRP incl. VAT)
	13 192,-	16 490,-

Prices Euro	(RRP ex. VAT)	(RRP incl. VAT)
	1 874,-	2 249,-



Gear table
– Item no. 411

Product type: Table lamp
Design: Johan Lindstén, 2018
Base, body and shade material: Steel
Base, body and shade colour: Black
Shade inner colour: White
Wire (with dimmer switch): Black, 200 cm
Bulb: E27, Max. 60 W (dimmable)
Voltage: 220V - 240V - 50/60Hz
Net weight: 6.1 kg
Minimum order size: 1

Dimensions and light direction:

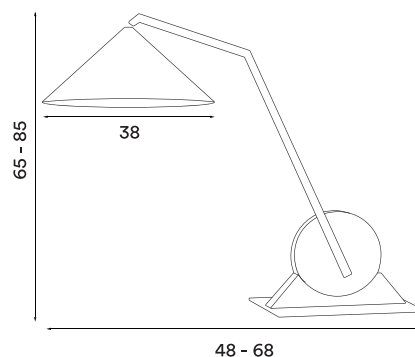

Recommended dimmable bulb:

 LED – 11 W

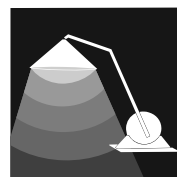

Prices NOK	(RRP ex. VAT)	(RRP incl. VAT)
	9 192,-	11 490,-

Prices SEK	(RRP ex. VAT)	(RRP incl. VAT)
	10 392,-	12 990,-

Prices DKK	(RRP ex. VAT)	(RRP incl. VAT)
	7 192,-	8 990,-

Prices Euro	(RRP ex. VAT)	(RRP incl. VAT)
	999,-	1 199,-

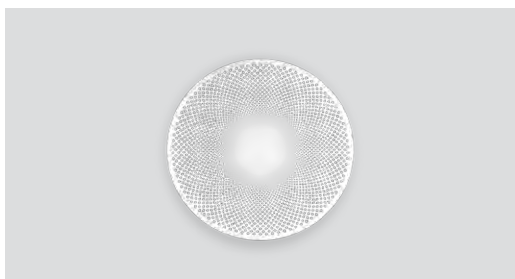

Glint wall white
– Item no. 265



Glint wall brass
– Item no. 266



Glint wall aluminium
– Item no. 267

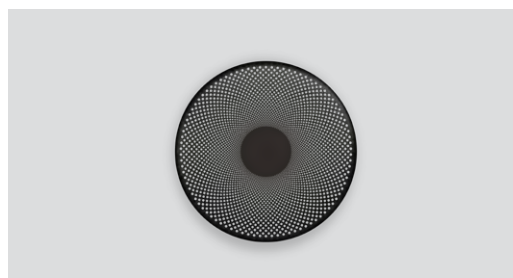

Glint wall black
– Item no. 268

Product type: Wall lamp

Design: Felix Isidorsson, 2022

Shade material: Steel, brass or aluminium

Shade colour: White, brushed brass, brushed aluminium or black

Body material: Steel

Body colour: White or black (black version only)

Wire: White (white and brass versions), black (black version) or transparent (aluminium version), 200 cm (with on/off switch)

Bulb: Integrated and dimmable LED 6 W, 550 lm, 2700 K, CRI > 85

Voltage: 220V - 240V - 50/60Hz

Net weight: 1.2 kg (white, black and brass versions), 0.8 kg (aluminium version)

Minimum order size: 2

Spare parts available: LED module

Dimensions and light direction:

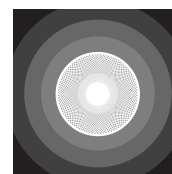
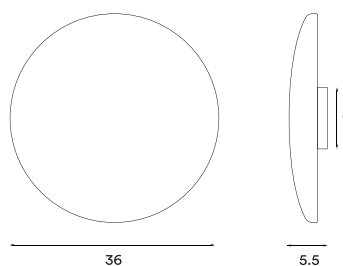

Light source included:

LED 6 W - Energy class: G/E



Prices NOK (RRP ex. VAT) (RRP incl. VAT)

White, black, alu	3 192,-	3 990,-
Brass	4 792,-	5 990,-

Prices DKK (RRP ex. VAT) (RRP incl. VAT)

White, black, alu	2 552,-	3 190,-
Brass	3 912,-	4 890,-

Prices SEK (RRP ex. VAT) (RRP incl. VAT)

White, black, alu	3 512,-	4 390,-
Brass	5 352,-	6 690,-

Prices Euro (RRP ex. VAT) (RRP incl. VAT)

White, black, alu	358,-	429,-
Brass	549,-	659,-



Heat pendant

P. 116



Heat pendant small brass
– Item no. 482



Heat pendant large brass
– Item no. 481



Heat pendant XL brass
– Item no. 485



Heat pendant small steel
– Item no. 483



Heat pendant large steel
– Item no. 484



Heat pendant XL steel
– Item no. 486

Product type: Pendant lamp series
Design: Johanna Forsberg, 2018
Shade material: Brass or steel metal mesh
Shade colour: Brass or steel
Body material: Steel
Body colour: Brass or steel
Wire: Black rubber, 370 cm
Bulb: E27, Max. 100 W
Voltage: 220V - 240V - 50/60Hz
Net weight small: 1.0 kg
Net weight large: 2.1 kg
Net weight XL: 4.2 kg (steel), 4.5 kg (brass)
Minimum order size: 1

Dimensions and light direction:

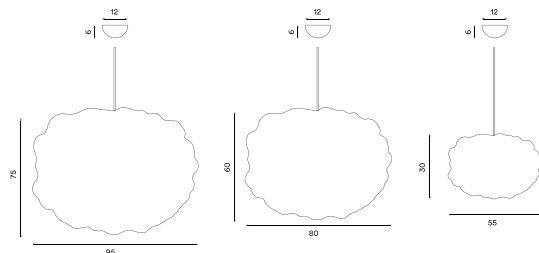

Recommended bulb:

 LED – 11 W

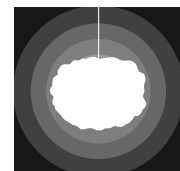

Prices NOK	(RRP ex. VAT)	(RRP incl. VAT)
Small	7 592,-	9 490,-
Large	9 592,-	11 990,-
XL	11 992,-	14 990,-

Prices DKK	(RRP ex. VAT)	(RRP incl. VAT)
Small	5 592,-	6 990,-
Large	7 192,-	8 990,-
XL	9 592,-	11 990,-

Prices SEK	(RRP ex. VAT)	(RRP incl. VAT)
Small	7 992,-	9 990,-
Large	10 392,-	12 990,-
XL	13 192,-	16 490,-

Prices Euro	(RRP ex. VAT)	(RRP incl. VAT)
Small	791,-	949,-
Large	1 041,-	1 249,-
XL	1 374,-	1 649,-



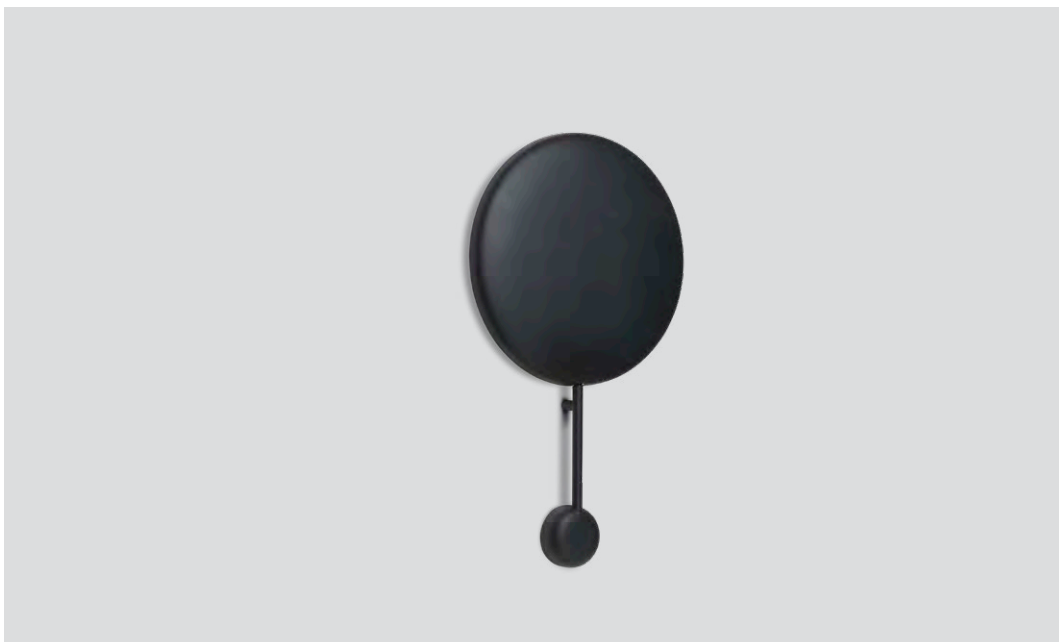

Ink wall black
- Item no. 269

Product type: Wall lamp
Design: Felix Isidorsson, 2019
Shade and body material: Steel
Shade and body colour: Black
Shade inner colour: White
Wire: Black, 200 cm (with on/off switch)
Bulb: Integrated and dimmable LED 6 W, 550 lm, 2700 K, CRI > 85.
Voltage: 220V - 240V - 50/60Hz
Net weight: 1.8 kg
Minimum order size: 2
Spare parts available: LED module

Dimensions and light direction:

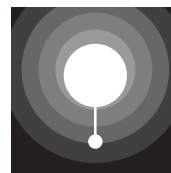
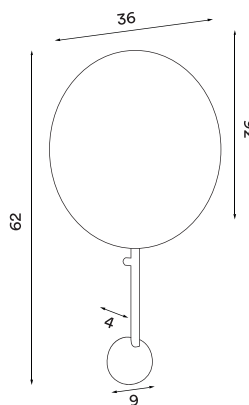

Light source included:

LED 6 W - Energy class: G/E



Prices NOK	(RRP ex. VAT)	(RRP incl. VAT)	Prices SEK	(RRP ex. VAT)	(RRP incl. VAT)
	3 752,-	4 690,-		4 152,-	5 190,-
Prices DKK	(RRP ex. VAT)	(RRP incl. VAT)	Prices Euro	(RRP ex. VAT)	(RRP incl. VAT)
	2 872,-	3 590,-		408,-	489,-



Kin table

P. 118



Kin table H33
– Item no. 761



Kin table H40
– Item no. 760

Product type: Table lamp
Design: Morten & Jonas, 2023
Shade material: Glass
Shade colour: Opal white matt
Body material: Dark Emperador marble stone
Body colour: Mixed brown marble
Wire: Black silk, 200 cm (with dimmer switch)
Bulb: Integrated and dimmable LED 8 W, 800 lm, 2700 K, CRI > 90
Voltage: 220V - 240V - 50/60Hz
Net weight: 3.0 kg (H33), 4.4 kg (H40)
Minimum order size: 2
Spare part available: Glass shade

Dimensions and light direction:

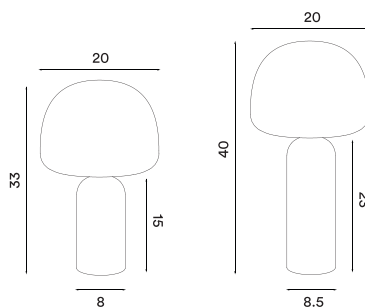

Light source included:

LED 8 W - Energy class: E



Prices NOK	(RRP ex. VAT)	(RRP incl. VAT)
Kin H33	3 192,-	3 990,-
Kin H40	3 592,-	4 490,-

Prices SEK	(RRP ex. VAT)	(RRP incl. VAT)
Kin H33	3 512,-	4 390,-
Kin H40	3 992,-	4 990,-

Prices DKK	(RRP ex. VAT)	(RRP incl. VAT)
Kin H33	2 392,-	2 990,-
Kin H40	2 792,-	3 490,-

Prices Euro	(RRP ex. VAT)	(RRP incl. VAT)
Kin H33	333,-	399,-
Kin H40	374,-	449,-





Me dim floor

P. 120



Me dim floor white
– Item no. 692

Me dim floor grey
– Item no. 693

Me dim floor petrol
blue – Item no. 694

Me dim floor black
– Item no. 695

Me dim floor warm
beige – Item no. 696

Product type: Floor lamp

Design: Morten & Jonas, 2015/2022

Body materials: Steel and silicone

Shade material: Steel

Shade and body colours: White, grey,
petrol blue, black or warm beige

Shade inner colour: White

Light diffuser material: Opal acrylic

Dimmer switch: Brass (on shade top)

Wire: Black, 200 cm

Bulb: Integrated and dimmable LED 13 W,
1200 lm, 2700 K, CRI > 85

Voltage: 220V - 240V - 50/60Hz

Net weight: 11.3 kg

Minimum order size: 1

Dimensions and light direction:

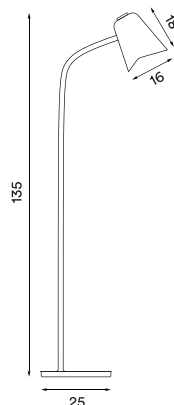

Light source included:

LED 13 W - Energy class: G



Prices NOK

(RRP ex. VAT) (RRP incl. VAT)

3 192,- 3 990,-

Prices SEK

(RRP ex. VAT) (RRP incl. VAT)

3 512,- 4 390,-

Prices DKK

(RRP ex. VAT) (RRP incl. VAT)

2 632,- 3 290,-

Prices Euro

(RRP ex. VAT) (RRP incl. VAT)

333,- 399,-



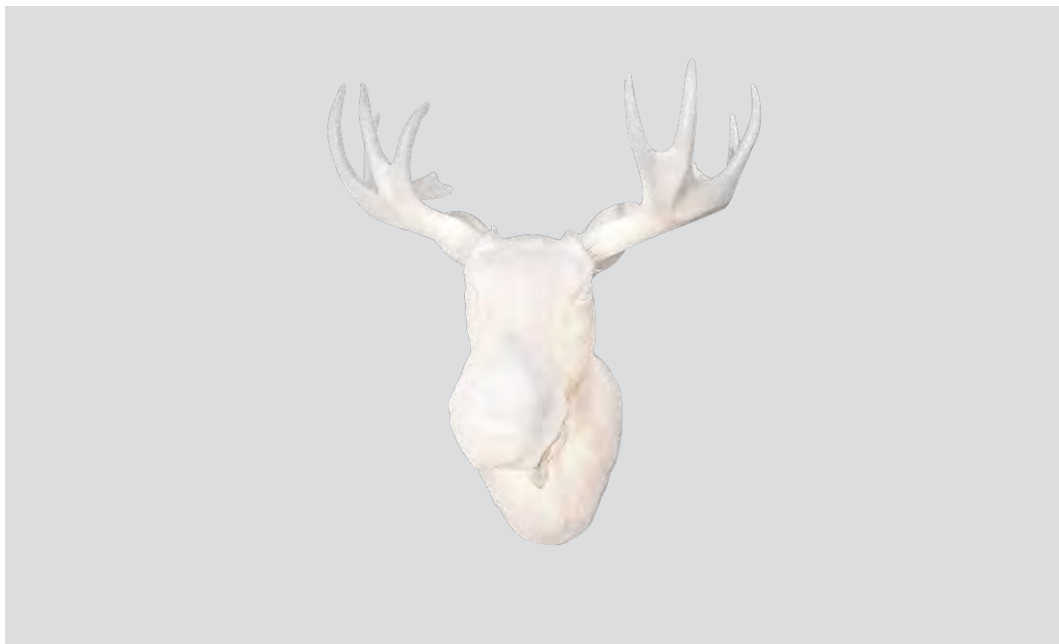

Moo wall
– Item no. 272

Product type: Wall lamp
Design: Trond Svendgård & Ove Rogne, 2008
Shade material: Polyresin and glass fibre
Shade colour: White
Body material: Steel
Wire: White, 200 cm (with on/off switch)
Bulbs main body: 2 x E27, Max. 20W LED
Bulbs horns: 2 x E14, Max. 7 W LED
Voltage: 220V - 240V - 50/60Hz
Net weight: 10 kg
Minimum order size: 1
Spare parts available: Light bulbs (2800K, warm white and 4000K, daylight)

Dimensions and light direction:

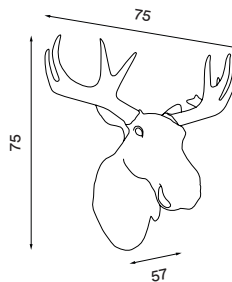

Bulbs included:

- 2 x E27 LED 7 W (4000K)
- Energy class: G
- 2 x E14 LED 5.5 W (4000K)
- Energy class: G

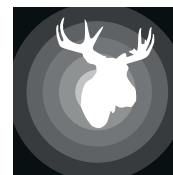

Prices NOK	(RRP ex. VAT)	(RRP incl. VAT)	Prices SEK	(RRP ex. VAT)	(RRP incl. VAT)
	18 952,-	23 690,-		20 792,-	25 990,-
Prices DKK	(RRP ex. VAT)	(RRP incl. VAT)	Prices Euro	(RRP ex. VAT)	(RRP incl. VAT)
	15 192,-	18 990,-		2 083,-	2 499,-

Ombre table

P. 122



Ombre table black
– Item no. 130



Ombre table warm beige
– Item no. 131

Product type: Table lamp
Design: Antoine Rouzeau, 2019
Shade and body material: Steel
Shade and body colour: Black or warm beige
Wire: Black, 200 cm (with on/off switch)
Bulb: GU10, Max. 6 W LED only
Voltage: 220V - 240V - 50/60Hz
Net weight: 1.4 kg
Minimum order size: 2

Dimensions and light direction:

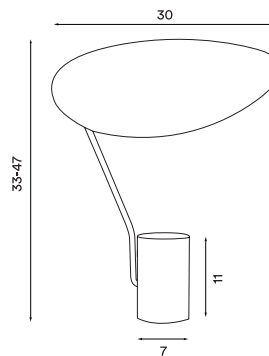

Recommended bulb:

 LED – 6 W



Prices NOK	(RRP ex. VAT) (RRP incl. VAT)		Prices SEK	(RRP ex. VAT) (RRP incl. VAT)	
		3 032,-		3 790,-	
Prices DKK	(RRP ex. VAT) (RRP incl. VAT)		Prices Euro	(RRP ex. VAT) (RRP incl. VAT)	
		2 392,-		2 990,-	





Oslo Wood beige shade – *Item no. 160*



Oslo Wood black shade – *Item no. 161*



Oslo Wood light blue shade – *Item no. 162*

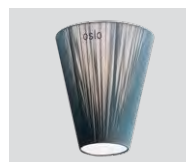

Oslo Wood green shade – *Item no. 163*



Oslo Wood white shade – *Item no. 164*



Oslo Wood olive green shade – *Item no. 165*



Oslo Wood caramel shade – *Item no. 166*



Oslo Wood steel feet – *Item no. 180*

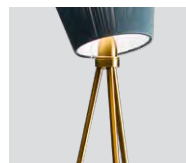

Oslo Wood gold feet – *Item no. 184*



Oslo Wood white matt feet – *Item no. 185*



Oslo Wood black matt feet – *Item no. 186*



Oslo Wood light grey feet – *Item no. 187*



Oslo Wood beige feet – *Item no. 188*

Product type: Floor lamp

Design: Ove Rogne, 2006

Shade material: Coloured chain link fabric

Shade colour: Beige, black, light blue, green, olive green, white or caramel

Body material: Steel

Body colour: Steel, gold, white matt, black matt, light grey or beige

Wire: Black, 200 cm

Dimmer switch: Black (on wire)

Bulb: E27, Max. 100 W (dimnable)

Voltage: 220V - 240V - 50/60Hz

Net weight: 3.9 kg

Minimum order size: 2

Spare parts available: Dimmer switch, bulb socket, shade fastening ring

Dimensions and light direction:

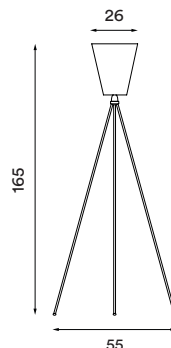

Recommended dimmable bulb:

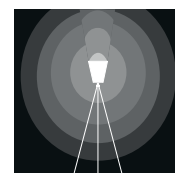

Prices NOK	(RRP ex. VAT)	(RRP incl. VAT)
Total	4 392,-	5 490,-
Shade	1 520,-	1 900,-
Feet	2 872,-	3 590,-

Prices SEK	(RRP ex. VAT)	(RRP incl. VAT)
Total	4 792,-	5 990,-
Shade	1 600,-	2 000,-
Feet	3 192,-	3 990,-

Prices DKK	(RRP ex. VAT)	(RRP incl. VAT)
Total	3 432,-	4 290,-
Shade	1 200,-	1 500,-
Feet	2 232,-	2 790,-

Prices Euro	(RRP ex. VAT)	(RRP incl. VAT)
Total	466,-	559,-
Shade	167,-	200,-
Feet	299,-	359,-



Over Me ceiling / wall

P. 124



Over Me D20 white – *Item no. 671*
 Over Me D20 dusty blue – *Item no. 672*
 Over Me D20 dark grey – *Item no. 673*
 Over Me D20 black – *Item no. 674*



Over Me D30 white – *Item no. 640*
 Over Me D30 dusty blue – *Item no. 641*
 Over Me D30 dark grey – *Item no. 642*
 Over Me D30 black – *Item no. 675*



Over Me D40 white – *Item no. 643*
 Over Me D40 dusty blue – *Item no. 644*
 Over Me D40 dark grey – *Item no. 645*
 Over Me D40 black – *Item no. 676*



Over Me D50 white – *Item no. 677*
 Over Me D50 dusty blue – *Item no. 678*
 Over Me D50 dark grey – *Item no. 680*
 Over Me D50 black – *Item no. 679*

Product type: Ceiling and wall lamp series

Design: Morten & Jonas, 2017

Body material: Steel

Body colour: White, dusty blue, dark grey or black

Shade material: Glass

Shade colour: Opal white matt

Bulbs: E27, Max. 2 x 7 W (P45 size) LED only (D20),

E27, Max. 2 x 13 W LED only (D30)

E27, Max. 3 x 13 W LED only (D40),

E27, Max. 4 x 13 W LED only (D50)

Voltage: 220V - 240V - 50/60Hz

Net weight: 1.5 kg (D20), 2.0 kg (D30),

3.1 kg (D40), 5.7 kg (D50)

Minimum order size: 2

Spare parts available: Glass shade

Dimensions and light direction:

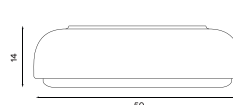
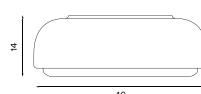
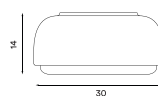
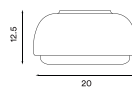

Recommended bulbs:



LED - 7 / 11 W

Prices NOK	(RRP ex. VAT)	(RRP incl. VAT)
D20	2 392,-	2 990,-
D30	2 792,-	3 490,-
D40	3 592,-	4 490,-
D50	4 792,-	5 990,-

Prices SEK	(RRP ex. VAT)	(RRP incl. VAT)
D20	2 632,-	3 290,-
D30	3 192,-	3 990,-
D40	4 152,-	5 190,-
D50	5 352,-	6 690,-

Prices DKK	(RRP ex. VAT)	(RRP incl. VAT)
D20	1 992,-	2 490,-
D30	2 312,-	2 890,-
D40	2 872,-	3 590,-
D50	3 832,-	4 790,-

Prices Euro	(RRP ex. VAT)	(RRP incl. VAT)
D20	266,-	319,-
D30	316,-	379,-
D40	408,-	489,-
D50	541,-	649,-



Reveal pendant

P. 125



Reveal pendant small – *Item no. 190*



Reveal pendant large – *Item no. 191*

Product type: Pendant lamp series
Design: Silje Nesdal, 2019
Shade material: Mouth blown glass
Shade colour: Grey
Body material: Aluminium and acrylic
Body colour: Brass matt and opal white
Wire: White rubber, 370 cm
Bulb: LED 10 W, 3000 K, 900 lm. Dimmable.
Voltage: 220V - 240V - 50/60Hz
Net weight: 3.5 kg (small), 4.4 kg (large)
Minimum order size: 1

Dimensions and light direction:

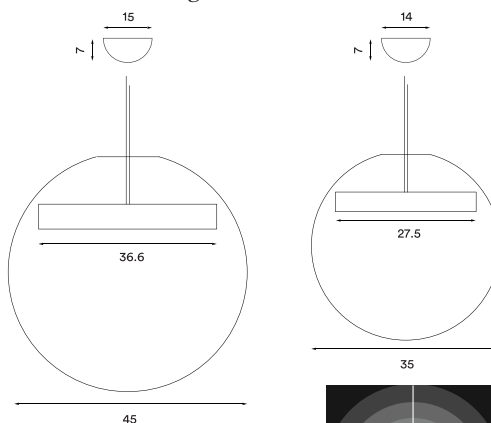

Light source included:

LED 10 W - Energy class: G



Prices NOK	(RRP ex. VAT)	(RRP incl. VAT)
Small (D35)	5 992,-	7 490,-
Large (D45)	7 992,-	9 990,-

Prices SEK	(RRP ex. VAT)	(RRP incl. VAT)
Small (D35)	6 392,-	7 990,-
Large (D45)	8 392,-	10 490,-

Prices DKK	(RRP ex. VAT)	(RRP incl. VAT)
Small (D35)	4 632,-	5 790,-
Large (D45)	6 152,-	7 690,-

Prices Euro	(RRP ex. VAT)	(RRP incl. VAT)
Small (D35)	624,-	749,-
Large (D45)	849,-	1 019,-



Salto floor

P. 126

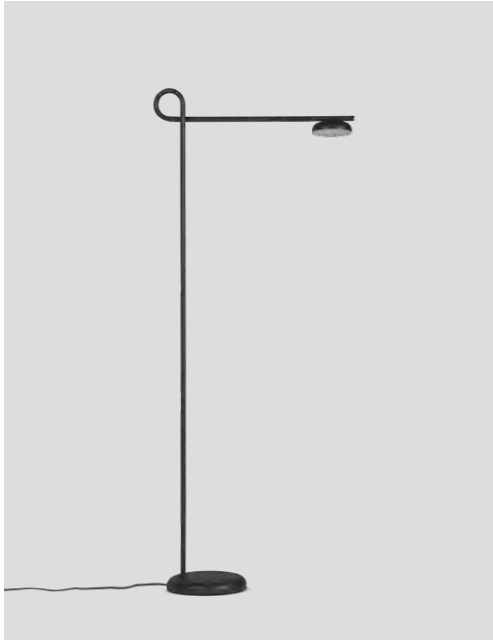

Salto floor black
- Item no. 734

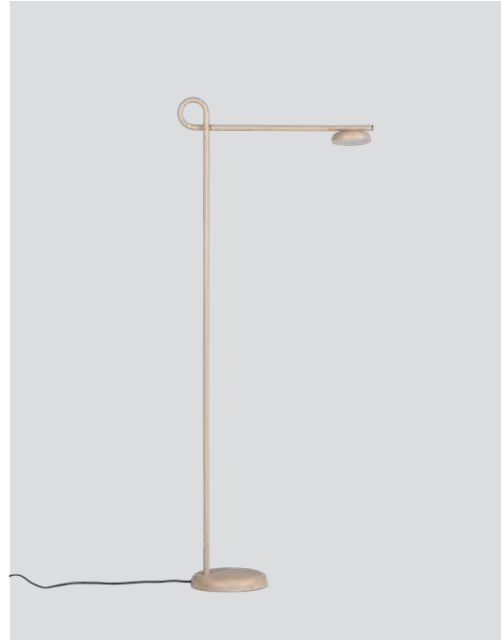

Salto floor beige
- Item no. 736

Product type: Floor lamp
Design: Gridy, 2022
Shade and body material: Steel
Shade and body colour: Black or beige
Light diffuser material: Opal acrylic
Wire: Black, 200 cm
Switch: 3-step touch dimmer (on lamp)
Bulb: Integrated LED 6 W, 550 lm, 2700/3000 K, CRI > 85, step dim
Voltage: 220V - 240V - 50/60Hz
Net weight: 5.4 kg
Minimum order size: 1

Dimensions and light direction:

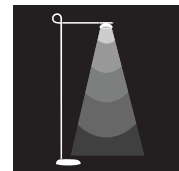
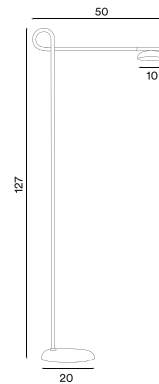

Light source included:

LED 6 W - Energy class: G/E



Prices NOK	(RRP ex. VAT)	(RRP incl. VAT)	Prices SEK	(RRP ex. VAT)	(RRP incl. VAT)
	3 992,-	4 990,-		4 392,-	5 490,-
Prices DKK	(RRP ex. VAT)	(RRP incl. VAT)	Prices Euro	(RRP ex. VAT)	(RRP incl. VAT)
	3 192,-	3 990,-		458,-	549,-



Salto table

P. 127



Salto table black
– Item no. 730



Salto table beige
– Item no. 732

Product type: Table lamp
Design: Gridy, 2022
Shade and body material: Steel
Shade and body colour: Black or beige
Light diffuser material: Opal acrylic
Wire: Black, 200 cm
Switch: 3-step touch dimmer (on lamp)
Bulb: Integrated LED 6 W, 550 lm, 2700/3000 K, CRI > 85, step dim
Voltage: 220V - 240V - 50/60Hz
Net weight: 2.5 kg
Minimum order size: 2

Dimensions and light direction:

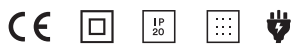
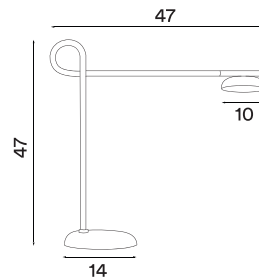

Light source included:

LED 6 W - Energy class: G/E



Prices NOK	(RRP ex. VAT)	(RRP incl. VAT)	Prices SEK	(RRP ex. VAT)	(RRP incl. VAT)
	3 112,-	3 890,-		3 432,-	4 290,-
Prices DKK	(RRP ex. VAT)	(RRP incl. VAT)	Prices Euro	(RRP ex. VAT)	(RRP incl. VAT)
	2 552,-	3 190,-		358,-	429,-





Say My Name pendant / table

P. 129



Say My Name pendant
smoked grey glossy – *Item no. 660*



Say My Name pendant
smoked grey matt – *Item no. 661*



Say My Name table
smoked grey glossy – *Item no. 662*



Say My Name table
smoked grey matt – *Item no. 663*

Product type: Pendant and table lamp series

Design: Morten & Jonas, 2015

Shade material: Mouth blown glass

Shade colour: Smoked grey glossy or smoked grey matt

Base material: Steel

Wire: Black rubber, 370 cm (pendant)
200 cm with switch (table)

Bulb: E27, Max. 60 W

Voltage: 220V - 240V - 50Hz

Net weight: 5.7 kg (pendant and table)

Minimum order size: 1

Dimensions and light direction:

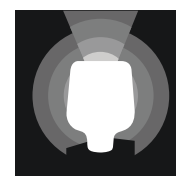
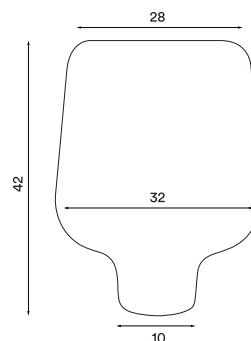

Recommended bulb:



Prices NOK

(RRP ex. VAT) (RRP incl. VAT)

8 792,-

10 990,-

Prices SEK

(RRP ex. VAT) (RRP incl. VAT)

9 592,-

11 990,-

Prices DKK

(RRP ex. VAT) (RRP incl. VAT)

6 792,-

8 490,-

Prices Euro

(RRP ex. VAT) (RRP incl. VAT)

916,-

1 099,-



Snowball floor

P. 130

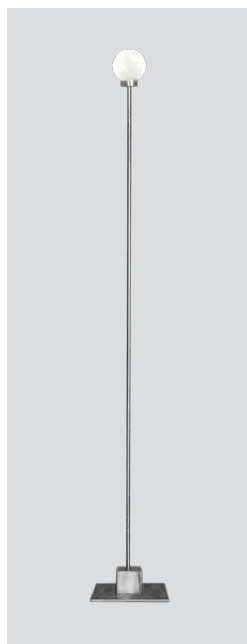

Snowball floor steel
– Item no. 714



Snowball floor white
– Item no. 715

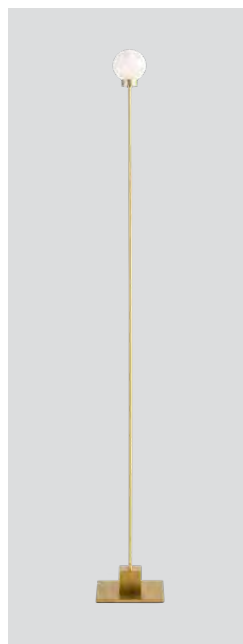

Snowball floor brass
– Item no. 716

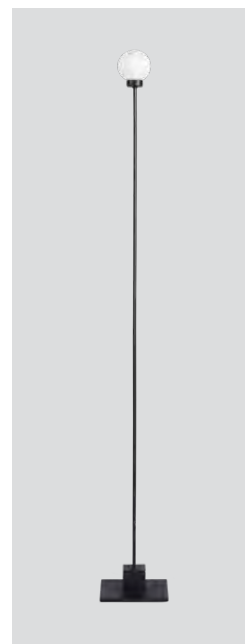

Snowball floor black
– Item no. 717

Product type: Floor lamp

Design: Trond Svendgård, 2005

Body material: Steel and aluminium or brass

Body colour: Steel, white, brass or black

Shade material: Mouth blown glass

Shade colour: Opal white matt

Wire (with dimmer switch): Transparent (steel and white versions), black (black and brass versions), 200 cm

Bulb: G9, Max. 6 W LED only (dimmable)

Voltage: 220V - 240V - 50/60Hz

Net weight: 1.6 kg

Minimum order size: 2

Spare part available: Glass shade, dimmer switch

Dimensions and light direction:

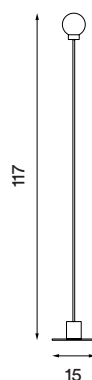

Recommended dimmable bulb:



LED – 3 W

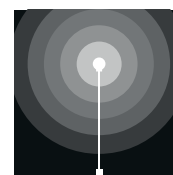

Prices NOK	(RRP ex. VAT)	(RRP incl. VAT)
Steel, white, black	2 392,-	2 990,-
Brass	2 952,-	3 690,-

Prices DKK	(RRP ex. VAT)	(RRP incl. VAT)
Steel, white, black	1 912,-	2 390,-
Brass	2 392,-	2 990,-

Prices SEK	(RRP ex. VAT)	(RRP incl. VAT)
Steel, white, black	2 632,-	3 290,-
Brass	3 192,-	3 990,-

Prices Euro	(RRP ex. VAT)	(RRP incl. VAT)
Steel, white, black	266,-	319,-
Brass	333,-	399,-



Snowball table

P. 131



Snowball table steel
– Item no. 710



Snowball table white
– Item no. 711



Snowball table brass
– Item no. 712



Snowball table black
Item no. 713

Product type: Table lamp

Design: Trond Svendgård, 2005

Body material: Steel and aluminium or brass

Body colour: Steel, white, brass or black

Shade material: Mouth blown glass

Shade colour: Opal white matt

Wire (with dimmer switch): Transparent (steel and white versions), black (black and brass versions), 180 cm

Bulb: G9, Max. 6 W LED only (dimmable)

Voltage: 220V - 240V - 50/60Hz

Net weight: 0.9 kg

Minimum order size: 2

Spare part available: Glass shade, dimmer switch

Dimensions and light direction:

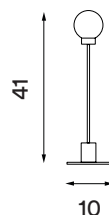

Recommended dimmable bulb:

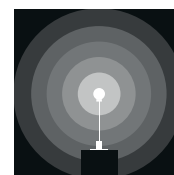

Prices NOK	(RRP ex. VAT)	(RRP incl. VAT)
Steel, white, black	1 992,-	2 490,-
Brass	2 392,-	2 990,-

Prices DKK	(RRP ex. VAT)	(RRP incl. VAT)
Steel, white, black	1 592,-	1 990,-
Brass	1 912,-	2 390,-

Prices SEK	(RRP ex. VAT)	(RRP incl. VAT)
Steel, white, black	2 152,-	2 690,-
Brass	2 632,-	3 290,-

Prices Euro	(RRP ex. VAT)	(RRP incl. VAT)
Steel, white, black	224,-	269,-
Brass	266,-	319,-



Tradition pendant

P. 132



Tradition pendant tall
– Item no. 740



Tradition pendant large oval
– Item no. 741



Tradition pendant small
– Item no. 742

Product type: Pendant lamp series
Design: Morten & Jonas, 2022
Shade material: Knitted polyester textile, steel
Shade colour: Off-white
Wire: White silk, 370 cm
Bulb: E27, Max. 13 W LED only
Voltage: 220V - 240V - 50/60Hz
Net weight tall: 3.3 kg
Net weight large oval: 4.0 kg
Net weight small: 2.8 kg
Minimum order size: 1

Dimensions and light direction:

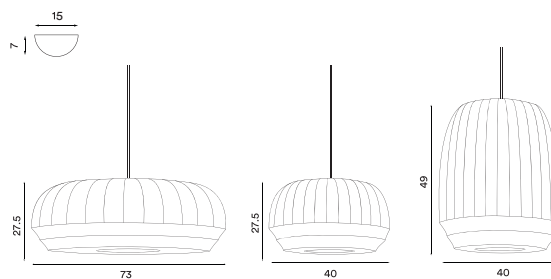

Recommended bulb:



Prices NOK	(RRP ex. VAT)	(RRP incl. VAT)
Small	3 192,-	3 990,-
Tall	3 752,-	4 690,-
Large oval	4 392,-	5 490,-

Prices DKK	(RRP ex. VAT)	(RRP incl. VAT)
Small	2 632,-	3 290,-
Tall	3 032,-	3 790,-
Large oval	3 592,-	4 490,-

Prices SEK	(RRP ex. VAT)	(RRP incl. VAT)
Small	3 512,-	4 390,-
Tall	4 072,-	5 090,-
Large oval	4 792,-	5 990,-

Prices Euro	(RRP ex. VAT)	(RRP incl. VAT)
Small	358,-	429,-
Tall	416,-	499,-
Large oval	499,-	599,-



Unika pendant

P. 133



Unika small transparent
– Item no. 530



Unika small grey
– Item no. 535



Unika small white
– Item no. 532



Unika large transparent
– Item no. 531



Unika large grey
– Item no. 536



Unika large white
– Item no. 533

Product type: Pendant lamp

Design: Anne Louise Due de Fønss
& Anders Lundqvist, 2012

Shade material: Mouth blown glass

Shade colour: Transparent, grey or opal white

Body material: Brass

Wire: Twisted fabric wire (black on transparent and grey versions, white on white version), 370 cm

Bulb: E14, Max. 60 W

Voltage: 220V - 240V - 50/60Hz

Net weight: 0.7 kg (small), 1.0 kg (large)

Minimum order size: 2

Spare parts available: Brass side screw,
cord grip canopy

Dimensions and light direction:

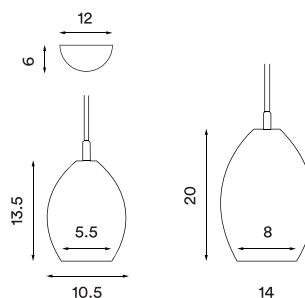

Recommended bulb:

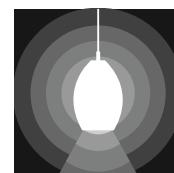

Prices NOK	(RRP ex. VAT)	(RRP incl. VAT)	Prices SEK	(RRP ex. VAT)	(RRP incl. VAT)
Small	2 392,-	2 990,-	Small	2 632,-	3 290,-
Large	2 712,-	3 390,-	Large	3 032,-	3 790,-
Prices DKK	(RRP ex. VAT)	(RRP incl. VAT)	Prices Euro	(RRP ex. VAT)	(RRP incl. VAT)
Small	1 912,-	2 390,-	Small	274,-	329,-
Large	2 232,-	2 790,-	Large	299,-	359,-



Spare parts

P. 134

Product name	Item no.	NOK RRP ex. VAT	NOK RRP incl. VAT	SEK RRP ex. VAT	SEK RRP incl. VAT
Foot dimmer LED (black)	1101	600,-	750,-	472,-	590,-
Hand dimmer LED (black or transparent)	1111, 1113	352,-	440,-	392,-	490,-
Oslo Wood bulb holder (black)	1001	280,-	350,-	312,-	390,-
Diva glass shade	1004	440,-	550,-	472,-	590,-
Snowball glass shade (D22/70)	1005	336,-	420,-	360,-	450,-
Snowball glass shade (D22/80)	1006	336,-	420,-	360,-	450,-
Moo bulb LED horn 5.5W (E14)	1007	312,-	390,-	360,-	450,-
Moo bulb LED head 7W (E27)	1008	336,-	420,-	360,-	450,-
Cord grip canopy matt (black or white metal)	1021, 1022	176,-	220,-	192,-	240,-
Acorn ceiling canopy matt (white, grey or black)	1054, 1055, 1056	399,-	499,-	412,-	515,-
Acorn hanging part matt (white, grey or black)	1057, 1058, 1059	880,-	1100,-	976,-	1220,-
Balancer floor/wall glass shade	1024	712,-	890,-	792,-	990,-
Over Me D20 glass shade	1035	960,-	1200,-	1040,-	1300,-
Over Me D30 glass shade	1025	1040,-	1300,-	1112,-	1390,-
Over Me D40 glass shade	1026	1320,-	1650,-	1432,-	1790,-
Over Me D50 glass shade	1036	1920,-	2400,-	2040,-	2550,-
Dahl large glass shade	444	2392,-	2990,-	2632,-	3290,-
Dahl small glass shade	495	1912,-	2390,-	1992,-	2490,-
Kin glass shade	1140	1160,-	1450,-	1272,-	1590,-
Hifive 75/100 glass door H37	1130, 1132	3672,-	4590,-	3992,-	4990,-
Hifive 75/100 glass door H74	1131, 1133	5752,-	7190,-	6392,-	7990,-

Spare parts

P. 135

Product name	Item no.	DKK RRP ex. VAT	DKK RRP incl. VAT	Euro RRP ex. VAT	Euro RRP incl. VAT
Foot dimmer LED (black)	1101	360,-	450,-	49,-	59,-
Hand dimmer LED (black or transparent)	1111, 1113	280,-	350,-	41,-	49,-
Oslo Wood bulb holder (black)	1001	224,-	280,-	35,-	40,-
Diva glass shade	1004	360,-	450,-	50,-	60,-
Snowball glass shade (D22/70)	1005	280,-	350,-	38,-	45,-
Snowball glass shade (D22/80)	1006	280,-	350,-	38,-	45,-
Moo bulb LED horn 5.5 W (E14)	1007	256,-	320,-	33,-	40,-
Moo bulb LED head 7 W (E27)	1008	264,-	330,-	38,-	45,-
Cord grip canopy matt (black or white metal)	1021, 1022	144,-	180,-	20,-	24,-
Acorn ceiling canopy matt (white, grey or black)	1054, 1055, 1056	340,-	425,-	47,-	56,-
Acorn hanging part matt (white, grey or black)	1057, 1058, 1059	712,-	890,-	99,-	119,-
Balancer floor/wall glass shade	1024	600,-	750,-	83,-	99,-
Over Me D20 glass shade	1035	800,-	1 000,-	108,-	129,-
Over Me D30 glass shade	1025	872,-	1 090,-	116,-	139,-
Over Me D40 glass shade	1026	1 112,-	1 390,-	149,-	179,-
Over Me D50 glass shade	1036	1 520,-	1 900,-	216,-	259,-
Dahl large glass shade	444	1 752,-	2 190,-	249,-	299,-
Dahl small glass shade	495	1 432,-	1 790,-	208,-	249,-
Kin glass shade	1140	872,-	1 090,-	124,-	149,-
Hifive 75/100 glass door H37	1130, 1132	2 792,-	3 490,-	391,-	469,-
Hifive 75/100 glass door H74	1131, 1133	4 392,-	5 490,-	624,-	749,-





Purpose and Definition

These Terms and Conditions define the collaboration between the Seller Northern.no AS, hereinafter referred to in this document as “Northern”, and the Reseller. These Terms and Conditions take precedent over any oral or written agreement, quote, order confirmation, or invoice.

The term Reseller is used in this document to describe a company which buys products from Northern with the purpose of reselling them to a Customer. Any Reseller must obtain written permission to sell Northern’s products. These Terms and Conditions define the Reseller’s non-exclusive rights to sell Northern’s products in a limited geographical area as agreed with Northern. In addition, a written confirmation must be issued by Northern specifying the right to sell Northern’s products online. Resellers offering Northern’s products online are regulated by additional Terms and Conditions for e-commerce as specified in this document.

The term Customer used in this document is intended to describe a person or company purchasing Northern’s products from the Reseller.

The terms “product”, “item” or “goods” used in this document refer to Northern’s Stock Keeping Units (SKU). SKUs refer to a certain product number in Northern’s Price List.

Northern’s current official Price List is the Recommended Retail Price List published on Northern’s website, www.northern.no, hereafter referred to as Northern’s Price List.

Commercial Restrictions

Northern is a high-end design brand which requires all Resellers to present the brand and our products in accordance with high standards of similar high-end design brands. Northern will continuously assess the Reseller both qualitatively and quantitatively to evaluate and determine the Reseller’s continued right to represent the brand and sell Northern’s products.

The Reseller’s business must always be conducted in a highly professional manner. The Reseller shall comply with all applicable laws, rules and regulations of government and other bodies, both nationally and internationally, including classifications requirements, laws, rules and any other regulations or policies which apply in the location where the sales, services and operational work is performed by the Reseller. The Reseller shall ensure that subcontractors and employed personnel adhere to the same strict legal adherence and these same terms & conditions set by Northern when relevant and applicable.

Northern reserves the right to define which of its products categories the Reseller may exhibit, promote, and resell. A Reseller must obtain a written confirmation from Northern to sell categories as specified by Northern.

The Reseller has the right to sell only the products listed in Northern’s Price List. Northern reserves the right to discontinue products at any point in time. See Northern’s website for reference.

The Reseller can purchase products only from Northern directly, via a licensed agent, or from a licensed distributor, depending on Northern’s market-specific setup. Contact Northern for further information about each market.

The Reseller has no right to act in Northern’s name, nor to enter into any agreements with any third party on Northern’s behalf.

International distribution

The Reseller can actively promote and resell Northern's products internationally only as agreed with Northern in writing, and only from the country where the Reseller's legal entity is officially registered. Resellers are not allowed to actively promote and resell Northern's products in markets serviced by exclusive distributors. Resellers are not allowed to promote or resell Northern's products to countries or regions which require certification, import documentation, or local governmental approvals not provided as standard by Northern and specified on the Northern website, nor to countries or regions which adhere to other technical standards than the standards offered by Northern and specified on the Northern website. The Northern standard products are CE approved only and can only be sold in countries which accept this standard. If any Northern items are promoted, resold, or distributed elsewhere, it will be at the Reseller's sole risk and liability.

If the Reseller maintains subsidiaries, or establishes or acquire separate legal entities in other countries than the country where the Reseller's legal entity is officially registered, including third party sub-contractors, these new entities have to be separately approved as a Reseller in writing by Northern before any exhibit, promotion, or resale of Northern's products may occur. Northern withholds the full right to refuse to accept trade with such entities.

The Reseller's Obligations

The Reseller is required to set an annual sales target in cooperation with Northern describing the minimum annual sales required to uphold the Reseller's right to sell Northern's products under the current agreement the Reseller has with Northern.

The Reseller is obligated to actively promote and sell Northern's products at the Reseller's own expense. Northern's brand and products must always be presented and displayed as a high-end design brand, and communicated correctly to Customers in accordance with the latest versions of the Northern brand and product data available, which is published on Northern's website, www.northern.no, with updated information about key features such as product information, technical specifications, price, designer, images, and all other relevant data as published by Northern.

The Reseller is furthermore required to utilize the most recent brand and marketing material published by Northern for any type of promotion. All translations, or reproduction, or edits and adjustments to any official material published by Northern must be pre-approved by Northern before publication or exhibition of such material.

The Reseller is required to utilize relevant content provided by Northern to the extent it is relevant to the Reseller's purposes. The Reseller is encouraged to actively use Northern's campaigns as specified in Northern's Campaign Plan as published on Northern's website, www.northern.no.

Northern requires all Resellers to retain adequate and updated knowledge about the Northern brand and products in order to present the brand to Customers in accordance with the available brand and product information, as well as the marketing and sales material, the communication tone and the values of the brand. Furthermore, the Reseller is obligated to ensure that all employees and representatives of the Reseller have completed adequate training and adhere to the brand and product information.

For the purposes of good customer relations and a close cooperation dialogue, adequate service ability and optimal operational production planning, the Reseller is expected to have close ongoing communication with Northern about any commercial projects that may involve products from Northern.

The Reseller is expected to inform Northern about any significant changes in operations, company ownership structure, management, staffing capacity or financial situation and risk without any further delay.



In case of product recalls, and to secure good processes related to any quality related issues, the Reseller is obligated to keep an updated and complete register of stocked and sold items, and will be expected to support Northern in solving any quality related issues all the way to the end Customers if needed.

See also the “Order and order confirmation” section for further operative obligations related to the order process.

Order and Order Confirmation

The Reseller is obligated to purchase SKUs following Northern’s minimum order sizes as described in Northern’s Price List. The minimum order size describes the number of the SKUs contained in an outer box. Any purchase order stating an amount less than the minimum order size will automatically be rounded up to the closest multiple of the minimum order size of the SKU, or alternatively a Split Fee will be added if a split is indeed required by the Reseller. Please refer to Northern’s Shipping Terms and Conditions for current fees.

Once an order is placed by the Reseller, an order confirmation will be sent to the Reseller no later than two (2) working days after receiving the order in writing. The order confirmation includes item specification, price, name of the Reseller, payment terms, delivery terms, delivery address and pick-up /delivery date. No order is valid until the written order confirmation is issued by Northern. Any date indicated on any order confirmation is to be considered as an estimate only, and Northern has no liability related to any change in the indicated delivery dates.

The Reseller is responsible for verifying all order confirmations issued by Northern and must inform Northern of any changes to the order, or errors in the order confirmation, within one (1) working day after receiving the order confirmation, otherwise the order will be effectuated. Specific shipping terms vary depending on which country the order is related to. See Northern’s Shipping Terms & Conditions for further details.

The Reseller is obligated to inform Northern without any delay if changes occur to any relevant company data, such as company name, registration number, contact details, shipping or payment addresses.

A quotation (“Quote”) is a description of the price offer for a specified product for a specific Reseller for a limited period. A quotation does not involve any reservation of stock. Northern must receive a written purchase order from the Reseller after a quotation is issued before an order confirmation is issued by Northern and any responsibility for Northern to deliver products comes into action. Any quotation given by Northern requires that the Reseller relays the quotation to the Customer without any amendment or change to its content. Northern is not responsible for any amendment or change the Reseller has made to a quotation.

Price

The price of Northern’s products follow the current Price List at any time. Note that all prices are periodically subject to change, normally on September 1st every year. Discounts and discount levels for permanent distribution agreements follow the individual contract with the Reseller, unless otherwise agreed upon in writing. Unless otherwise stated, all net prices to the Reseller in any quotation or order confirmation are exclusive of shipping and insurance, and exclusive of VAT. The Reseller can only place orders in the currency selected by Northern for that Reseller.

Where no net price has been quoted, or a quoted price is no longer valid, or errors have been made in the quotation or order confirmation, the price listed in Northern’s Price List at the time of the order acceptance date will be the valid price of the product, unless a valid distribution agreement states otherwise.

Cancellation and return of goods

No confirmed order by Northern can be cancelled by the Reseller without a written approval from Northern. If no written approval of order cancellation is issued by Northern, the Reseller is accountable for the order and shall indemnify Northern in full against all losses (such as order value, indirect costs, other charges and expenses incurred) as a result of any such cancellation, even if products are not yet delivered.

No product can be returned to Northern without a written agreement with Northern. Any product returned by the Reseller without prior confirmation from Northern, and through no fault of Northern's, will be subject to billing of all related losses (such as order value, indirect costs, damages, other charges and expenses incurred). Returned goods by postal claim to Northern or its local sales representative will not be collected or paid for by Northern.

Product items made specifically for each client, defined and marked by Northern as Made-to-order items in Northern's Price List, as well as any customized items, may not be cancelled or returned under any circumstance.

Payment terms

All orders, unless otherwise agreed upon in writing between the Reseller and Northern in advance, are subject to prepayment prior to delivery.

Credit may be granted for Resellers with approved credit evaluation, repetitive order placement, and a solid and proven track record and cooperation history in certain markets. In case of planned or initiated ownership changes, and/or other significant changes to the Resellers' financial situation and risk that may affect Northern, the Reseller should immediately and without any further delay inform Northern about these changes for a renewed credit evaluation. Northern holds the right to withdraw any credit agreement at any point in time without further notice.

Invoices from Northern must be paid no later than the due date specified on the invoice. Exceptions shall always be approved in writing by Northern in advance if any further credit extension is to be granted under exceptional circumstances.

In case of late payment, reminder fees and interest related to outstanding payments will be added to the original invoice value. Specific charges and interests vary, and further charges and interests will depend on the fees applied by Northern's external partners, such as invoicing, factoring, and debt collection agencies. Unpaid invoices will ultimately be transferred to a debt collecting agency if the invoice remains unpaid without any further notice.

Delivery terms

Ex Works shipping is the default shipping method for all orders received by Northern. For selected resellers in certain markets Northern offers to ship goods to Resellers against payment for transportation. Details about shipping terms for each market are stated in Northern's Shipping Terms & Conditions relevant for the market in question.

The order confirmation from Northern specifies which delivery terms apply for each specific order.

All warehousing and handling costs related to delays to planned shipping caused by the Reseller, and/or related to items not being picked up according to agreed deadlines at the Northern warehouses or factories will be charged in full to the Reseller.

If or when Northern offers to ship goods to its Reseller against payment of transportation, the delivery of goods will be to the place and address specified in the order confirmation issued from Northern, with delivery information including date and time as specified therein. Unless otherwise instructed in writing, Northern will ship by the method of Northern's choosing. The payment for cost of transport will be added to the invoice based on Northern's Shipping Terms & Conditions.



Additional fees may incur if the Reseller or the Reseller's Customer require additional documentation or services other than the standard Northern Order Confirmation, such as, but not limited to, custom packaging or labelling data, or other formats that are not standard to Northern, or export documents, such as Country of Origin documentation.

For DAP deliveries, the Reseller is obligated to inform Northern of any restrictions, limitations, or alterations in delivery hours during the day, week and year related to any order, as well as other known restrictions in terms of admission, access or transportation hinderances for a large vehicles etc. to the physical location where the delivery is to be made. Northern delivers within standard opening hours in accordance with specific policies and services as specified by the selected carrier. For deliveries not in accordance with the standard services as specified by the selected carrier charges will apply.

Note that products not marked with "made-to-order" in Northern's Price List will commonly be in stock. Stocked items can be sold out periodically, and the Reseller is therefore required to contact Northern for the latest updates on the current stock situation for the products in question, and should always receive an order confirmation from Northern before making any binding offers to its Customer.

Estimated delivery time for items marked as "made-to-order" in Northern's Price List is specified on the order confirmation issued by Northern.

Note that there might be longer delivery time than specified in the order confirmation in seasons of high demand or during vacation periods, or if there are delaying reasons beyond our control such as supplier break downs, material shortages, or force majeure.

Any dates specified by Northern in any quotation or order confirmation are intended as an estimate only. Under no circumstances shall Northern be held responsible or liable for any loss or damage of any kind caused by any delay in the supply of the goods or services, unless otherwise has been agreed specifically in writing in beforehand of an order confirmation. Any liability Northern has for non-delivery of goods shall be limited to delivering or replacing the missing or damaged goods within 6 months, or alternatively Northern retains the right to issue a credit note against any invoice value for these products in such situations.

No products are sent from Northern to any domestic households on behalf of the Reseller or any Customer.

Guarantee

A standard production guarantee of one (1) year applies to all products from Northern, unless local laws, regulations, or specific agreements regarding particular orders stipulate otherwise.

Warranty conditions apply only to standard products that have not been reworked or modified by the user, the Customer, or the Reseller.

Claims

For visible damages, defects, or incorrect type or quantity identified on arrival, the Reseller is responsible for obtaining a signed damage declaration / deviation report from the transporter for the claim to take effect. Such deviations must also be reported to Northern no later than two – 2 – working days after delivery together with a copy of the signed transporter damage declaration.

Product errors must be reported immediately after they are identified by the Reseller or the Customer. A standard format supplied by Northern for claims reporting applies to all claims. Photos, damage description and product batch information must always be included in the claims reporting to Northern. Local consumer laws regulating warranty and claims may apply.

Northern or its local sales representative has the right to inspect any product subject to claims or deviations, including transportation damages. Northern or its local sales representative has the right to conduct any reasonable actions to repair items, or reduce the scope or cost of damage, or potential replacement. No product can be disposed of, or returned to Northern, unless specifically agreed upon in writing between the parties.

Northern is not responsible for any damage or defect caused by the Reseller or Customer after the item is delivered from Northern, including damages or defects caused in storage, transportation, display, or handling.

Repairs or any modification to a product performed by the Reseller or the Customer will not be compensated for unless this has been specifically agreed upon in writing by Northern prior to execution.

Claims or deviation compensation from Northern to the Reseller is limited to the product value, and further limited to situations related to product error, correction of erroneously delivered goods, and/or delivery of an erroneous product, or lack of delivery. Indirect damages, for example costs or loss associated with the Reseller's product handling, sales, or distribution etc., are not subject to any compensation, claim or payment between the parties. Further, any third-party damages, costs, or loss, are not subject to any claim or payment between the parties.

Restrictions

None of the parties have the authority to act on the other party's behalf, nor to engage in any commitment toward any third party on the other's behalf.

Northern has the right to change construction, materials, weight, and any other measurements of products without any prior notice, as long as this does not significantly change the product. The Northern website is the point of reference for any correct updated and valid product specifications.

Northern shall have no liability towards the Reseller for any failure to deliver the goods or any delay in doing so or for any damage or defect to the goods delivered that is caused by an event or circumstance beyond Northern's reasonable control (*force majeure*), including, without limitation, strikes, lock-outs and other industrial disputes, breakdown of systems or network access, flood, fire, explosion, death or accidents. Furthermore, Northern has no liability for products not correctly assembled according to the Northern User Manuals, or in violation of any applicable laws or standards.

The goods are manufactured and sold in accordance with the EC directives, declaring that the goods comply with the essential health and safety requirements for the European market, furthermore they are CE approved and are CE labelled. No other local, national, or regional approval or conformity standard is provided by Northern unless agreed to in writing, and the Reseller should renounce distribution or use of the goods as sold where other approval or standard may be required. Any such distribution or use is the sole responsibility of the Reseller, and any legal dispute or claim thereof from any third party should be directed towards and handled by the Reseller.



Northern is not responsible for any information, advice, or any recommendations given by our sales representatives, staff, retailers or our other partners and affiliates to the Reseller unless they are confirmed in writing by Northern. If acted upon, this is entirely at the Reseller's own risk, and accordingly, Northern shall not be liable for any such information, advice, or recommendation.

Any typographical, clerical or otherwise, error or omission in any official Northern sales literature, quotation, Price List, acceptance of offer, invoice, or any other document or information issued by Northern shall be subject to ongoing correction without any liability on the part of Northern.

All images, renderings, and descriptions of products, including colours and materials presented by Northern on any of its platforms are indicative. Variations in colours and material nuances naturally vary over time and in use.

Rights protection

Products from Northern, including any drawings, specifications, product or material design elements, patents, trademarks, market related material and/or know-how are owned by Northern, and shall remain Northern's property, throughout and after termination of the business relationship between Northern and the Reseller.

Confidentiality

The parties may not under any circumstance distribute or reveal matters of vital interest or any confidential information to a third party during or after the business relationship between Northern and the Reseller.

Disputes

This contract shall be governed by, and interpreted, in accordance with Norwegian law and the Norwegian courts shall have jurisdiction to resolve any disputes between Northern and the Reseller.

Any legal disputes between the parties should be solved through direct negotiations. If direct negotiations do not solve the dispute, legal mediators, Norwegian law, and the Norwegian courts may be used.

Additional Terms and Conditions for e-Commerce

Unless otherwise expressly agreed in writing, all sales are subject to the following Terms and Conditions specific to online sales, in addition to the above General Terms and Conditions. Notwithstanding any other provision of the contract, nothing in the contract confers or purports to confer any right to enforce any of its terms on any person or third party who is not a party to it.

Obligations of the Reseller

The Reseller cannot promote or resell Northern's products on any other website than the official Reseller website approved by Northern. Any website for the distribution of Northern's products must be approved by Northern prior to launching. The Reseller cannot promote or resell Northern's products on any third-party online store such as eBay, Amazon, or the like.

Northern expects the Reseller to sustain the same level of brand knowledge, product knowledge, technical knowledge, after service competencies, and to provide the same level of service towards the Customer, as one can expect from any physical Northern retailer or distribution partner.

The functionality on the Reseller's website must be at a satisfactory level compared to the industry standard, or other relevant benchmarks. The domain name must correspond to the Resellers brand name so that the Customer can easily identify that the Reseller is the brand owner of the website.

The Resellers' website domain name or company name cannot solely contain the word "Northern" or any Northern product name, such as "Acorn". However, the Reseller can maintain a subdomain branded as a specific Northern subdomain or Northern product domain of the Reseller's website if it is approved by Northern in writing. Any product names of Northern's products are the property of Northern alone. The Reseller cannot use these names in a way that it can look like they belong to the Reseller and the name should always be displayed together with and in conjunction to the Northern brand name and brand logo. Examples of such names are: Acorn, Buddy, Oaki, etc.

The Reseller must continually update websites with the most recent Northern logo and brand name, all relevant marketing material, product information, prices, product images and product names, reflecting the current product names, product description and technical specifications and an updated presentation of the overall product portfolio.

The Reseller can only display official brand and product images that are supplied by Northern, unless otherwise has been agreed in writing. All materials not provided by Northern should be approved by Northern prior to publishing on the Resellers' website.

Any question or comment from Customers related to Northern or our products on the Resellers' website must be replied to correctly and in a timely fashion by the Reseller.

Without compromising the Resellers' right to set their own prices, the Reseller cannot present the discount on the product as the main online content. The quality and design of the Northern brand and products shall be the main content in the online presentation and marketing of Northern products. The Reseller is responsible to comply with any legal requirements, data protection laws, e-commerce laws, and any other current legal requirements protecting the Customer. The Reseller is responsible for protecting the Customers online payment in a way that complies with current online payment security standards.

All market communication, including all claims handling or after sales communication with the Customer, shall be handled by the Reseller only and not by Northern. Transportation of goods, including transport prices, choice of transport price models, delivery information, and information about delays towards the Customer is solely a matter between the Reseller and the Customer.

Minimum quantities apply for the ordering of certain SKUs – see Northern's Price List for further details. SKUs not kept in stock by the Reseller should not be sold as "available on demand" and should be clearly presented as a non-stock item or listed with the appropriate expected delivery time.



Contact us

Northern
Bygdøy allé 68
0265 Oslo, Norway

(+47) 40 00 70 37
post@northern.no
northern.no

Follow us

Facebook – [northern.no](#)
Instagram – [northern.no](#)
Pinterest – [northernoslo](#)